

**Aircraft Operating Instruction (AOI),
Pilot Operating Handbook (POH)
and Flight Training Supplement
Evolution Aircraft, Inc.
REVO**

Revision 7.2

Part Type	Model	Serial Number
Carriage	Revo	
Carriage	Empty Weight	
Wings	Rival S RIVAL X Competition Discovery Rival (Discontinued) Reflex Sport (Discontinued)	
Wing	Empty Weight	
Engine	912UL, 912ULS, 912iS	
Propeller	Warp Drive, Sensenich, E-Props	
Registration Number		

Evolution Aircraft Inc.
39440 South Ave
Zephyrhills, FL 33542
USA
May 1, 2023
e-mail:
Evolutiontrikes@yahoo.com

Page intentionally left blank

Amendments:

Date Of Amendment	Sections Affected	Pages Affected	Date Inserted	Signature
Nov 5, 2010	ALL (Revision 2.0)	ALL		
Dec. 8, 2012	ALL (Revision 3.0)	ALL		
June 5, 2013	ALL (Revision 4.0)	ALL		
March 1, 2014	ALL (Revision 5.0)	ALL		
November 11, 2015	SECTIONS 9, 10, 11	118, 119		
February 1, 2016	ALL (Revision 7.0)	ALL		
March 15, 2017	ALL (Revision 7.1)	ALL		
May 1, 2023	Propeller (Revision 7.2)	17, 90	May 1, 2023	

NOTE

Manuals can be revised in the future and pages and/or sections re-issued. Amendments will also be available on the distribution website www.evolutiontrikes.com . The amended pages and/or sections should be printed and replaced in the manual at the earliest possible time for safety of flight. The amendment should be logged and recorded in the table above by the owner.

Operator's Responsibility:

WARNING

THERE ARE INHERENT RISKS IN THE PARTICIPATION IN RECREATIONAL AVIATION AIRCRAFT. OPERATORS AND PASSENGERS OF RECREATIONAL AIRCRAFT, BY PARTICIPATION, ACCEPT THE RISK INHERENT IN SUCH PARTICIPATION ON WHICH THE ORDINARY PRUDENT PERSON IS OR SHOULD BE AWARE. PILOTS AND PASSENGERS HAVE A DUTY TO EXERCISE GOOD JUDGMENT AND ACT IN A RESPONSIBLE MANNER WHILE USING THE AIRCRAFT AND TO OBEY ALL ORAL OR WRITTEN WARNINGS, OR BOTH, PRIOR TO OR DURING USE OF THE AIRCRAFT, OR BOTH.

Copyright Evolution Aircraft, Inc.

The data and information contained in the document is the property of Evolution Aircraft, Inc. This document may not be reproduced or transmitted to a third party, in any form or by any means. Any unauthorized copy, distribution is illegal as per international agreements relating to property rights.

WARNING

THE OWNER AND OPERATOR MUST UNDERSTAND THAT DUE TO INHERENT RISK INVOLVED IN FLYING AN AIRCRAFT, NO WARRANTY IS MADE OR IMPLIED, OF ANY KIND, AGAINST ACCIDENTS, BODILY INJURY OR DEATH OTHER THAN THOSE, WHICH CANNOT BY LAW BE EXCLUDED.

THE SAFE OPERATION OF THIS AIRCRAFT RESTS WITH YOU, THE PILOT. WE BELIEVE THAT IN ORDER TO FLY SAFELY YOU MUST MATURELY PRACTICE AIRMANSHIP. OPERATIONS OUTSIDE THE RECOMMENDED FLIGHT ENVELOPE SUCH AS AEROBATIC MANEUVERS OR ERRATIC PILOT TECHNIQUE MAY ULTIMATELY PRODUCE EQUIPMENT FAILURE. YOU ARE REFERRED TO THE OPERATING LIMITATIONS IN THIS MANUAL.

LIKE ANY AIRCRAFT, SAFETY DEPENDS ON A COMBINATION OF CAREFUL MAINTENANCE AND YOUR ABILITY TO FLY INTELLIGENTLY AND CONSERVATIVELY. WE HOPE THAT YOUR AIRCRAFT WILL PROVIDE YOU WITH MANY HOURS OF SAFE AND ENJOYABLE FLYING.

THIS AIRCRAFT WAS MANUFACTURED IN ACCORDANCE WITH LIGHT SPORT AIRCRAFT AIRWORTHINESS STANDARDS AND DOES NOT CONFORM TO STANDARD CATEGORY AIRWORTHINESS REQUIREMENTS.

This aircraft is to be operated in compliance with the information and limitations contained herein.

TABLE OF CONTENTS

AMENDMENTS	3
AMENDMENTS NOTE	3
1 GENERAL	10
1.1 INTRODUCTION	11
1.2 DEFINITIONS, TERMINOLOGY AND ABBREVIATIONS	11
1.3 GENERAL DESCRIPTION	15
1.3.1 Carriage	15
1.3.2 Wings	15
1.3.3 Engines	15
1.3.3.1 Rotax 912UL	15
1.3.3.2 Rotax 912ULS	16
1.3.3.3 Rotax 912iS	16
1.3.4 Propellers	17
1.3.4.1 Warp Drive	17
1.3.4.2 Sensenich Propeller for the Rotax 912 Series Engines	17
1.3.4.3 E-Props Propeller	17
1.3.5 Fuel	17
1.4 DIMENSIONS	18
1.5 VIEWS	20
1.5.1 Front	20
1.5.2 Side	21
1.5.3 Back	22
2 LIMITATIONS	23
2.1 GENERAL	23
2.2 AIRSPEED LIMITATIONS	23
2.2.1 Competition 11	23
2.2.2 Reflex Sport 12.5 (discontinued)	23
2.2.3 Discovery 13.5	24
2.2.4 Rival 12.4 (discontinued)	24
2.2.5 Rival S 12.4	25
2.2.6 Rival X 14.0	25
2.3 ENGINE OPERATING LIMITATIONS	26
2.3.1 Rotax 912UL	26
2.3.2 Rotax 912ULS	27
2.3.3 Rotax 912iS	28
2.4 ENGINE OPERATING MEDIA	29
2.5 FUEL AND OIL CAPACITY	29
2.5.1 Fuel Capacity	29
2.5.2 Oil Capacity	29
2.6 AIRCRAFT OPERATIONAL AND MANEUVERING LIMITS	30
2.6.1 Center of Gravity Limits	30
2.6.2 Maneuvering Limits and Loads	31
2.6.3 Minimum Flight Crew and Crew Weight	31
2.6.4 Maximum Passenger Seating Limit	32
2.6.5 Operating Limits	32
2.6.5.1 Environmental Restrictions	33
2.6.6 Minimum Equipment List	34
3 EMERGENCY PROCEDURES	35
3.1 GENERAL	35
3.2 AIRSPEEDS FOR EMERGENCY OPERATION	35

3.3 EMERGENCY PROCEDURES CHECKLISTS36

3.3.1 Engine Out on Climb Out36

3.3.2 Engine Failure at Altitude37

3.3.3 Stuck Throttle at Full Power (In Flight)38

3.3.4 Emergency Landings38

3.3.5 Engine Fire While In-Flight38

3.3.6 Engine Fire On Ground39

3.3.7 Propeller Damage39

3.3.8 Sail Damage39

3.3.9 Ballistic Recovery Systems - Parachute (optional).....40

3.3.10 Ignition Circuit Failure42

3.3.11 Spins and Spiral Descents42

3.3.12 Unusual Attitudes42

3.3.12.1 Nose High Attitude42

3.3.12.2 Nose Down Attitude43

3.3.13 Instrument Failure or Warnings43

3.13.13.1 Course of Action for Engine Monitoring and Low Fuel Warnings43

3.13.13.1.1 CHT High44

3.13.13.1.2 Oil Temperature At or Above Red Line44

3.13.13.1.3 Fuel Level Warning45

3.13.13.1.4 Oil Pressure Warning45

4 NORMAL PROCEDURES46

4.1 GENERAL46

4.1.1 Speeds for Normal Operation46

4.1.1.1 Competition 1146

4.1.1.2 Reflex Sport 12.5 (discontinued)46

4.1.1.3 Discovery 13.546

4.1.1.4 Rival 12.4 (discontinued)47

4.1.1.5 Rival S 12.447

4.1.1.6 Rival X 14.047

4.1.2 Normal Procedures Check List47

4.2 WING ASSEMBLY PROCEDURE47

4.3 WING PRE-FLIGHT INSPECTION48

4.4 ATTACHING WING TO TRIKE CARRIAGE49

4.5 COMPLETE TRIKE CARRIAGE PRE-FLIGHT INSPECTION52

4.6 FUELING53

4.6.1 Fuel Gascolator53

4.6.2 Fuel Level53

4.6.3 Fuel Vent53

4.6.4 Quick Drain54

4.7 HELMET, EAR AND EYE PROTECTION REQUIREMENT54

4.8 NORMAL PROCEDURES CHECK LIST54

4.8.1 Before Engine Start54

4.8.2 Starting Engine55

4.8.3 Taxiing56

4.8.4 Before Take Off57

4.8.5 Take Off and Initial Climb58

4.8.5.1 Normal Take Off and Initial Climb58

4.8.6 Climb58

4.8.7 Cruise59

4.8.8 Descent59

4.8.9 Landing60

4.8.10 Crosswind Operation61

4.8.10.1 Crosswind Take Off and Initial Climb61

4.8.10.2 Crosswind Landing61

4.8.11 After Landing62

4.8.12 Parking the Aircraft62

4.8.13 Go Around	63
4.8.14 Ideal Minimum Safe Runway Length	63
4.9 SEPARATING WING FROM TRIKE CARRIAGE	64
4.10 WING BREAKDOWN PROCEDURE	64
4.11 TRANSPORTATION AND STORAGE	65
4.11.1 Transporting by Trailer	65
4.11.2 Packed in a Crate	66
4.11.3 Parachute	66
4.11.4 Storage	66
5 PERFORMANCE	67
5.1 GENERAL	67
5.2 TAKE OFF AND LANDING	67
5.2.1 Take Off	67
5.2.1.1 ISA Conditions, Clean Dry Runway, Calm Winds, Standard Day	67
5.2.1.2 3000ft (914 m) Density Altitude, Clean Dry Runway, Calm Winds	67
5.2.2 Landing	68
5.2.2.1 ISA Conditions, Clean Dry Runway, Calm Winds	68
5.2.2.2 3000ft (914 m) Density Altitude, Clean Dry Runway, Calm Winds	68
5.3 CLIMB	69
5.3.1 ISA Conditions, Calm Winds, Sea Level, MTOW	69
5.3.2 ISA Conditions, Calm Winds, Sea Level, 820lbs (373kg)	70
5.3.3 3000ft (914m) Density Altitude, Calm Winds, MTOW	72
5.3.4 3000ft (914) Density Altitude, Calm Winds, 820lbs (373kg)	73
5.4 STALL SPEEDS	74
5.5 GLIDE	75
5.5.1 Max Glide Speeds to Fly (Rules Of Thumb)	75
5.6 CRUISE	75
6 WEIGHT AND LOADING	76
6.1 CENTER OF GRAVITY LIMITS	77
7 DESCRIPTION OF THE AIRCRAFT AND ITS SYSTEMS	78
7.1 GENERAL	78
7.2 AIRFRAME	78
7.2.1 Wing	85
7.2.1.1 Competition 11	85
7.2.1.2 Reflex Sport 12.5 (discontinued).....	85
7.2.1.3 Discovery 13.5.....	85
7.2.1.4 Rival 12.4 (discontinued)	85
7.2.1.5 Rival S 12.4	85
7.2.1.6 Rival X 14.0.....	85
7.2.2 Carriage	86
7.3 FLIGHT CONTROLS	87
7.4 GROUND / FLIGHT CONTROL	87
7.5 INSTRUMENTATION	87
7.6 ELECTRIC IN-FLIGHT TRIM SYSTEMS.....	88
7.6.1 Electric In-Flight Speed Trim	88
7.6.2 Electric In-Flight Roll Trim	88
7.7 OCCUPANT RESTRAINT HARNESS	89
7.8 ENGINE	89
7.9 CARBURETOR HEATING	89
7.10 PROPELLER	90
7.11 BRAKE SYSTEM	90
7.12 ELECTRICAL SYSTEM 912UL, 912ULS, 912iS	90
7.13 PITOT STATIC SYSTEM AND INSTRUMENTS	91
7.14 STRATOMASTER ULTRA HORIZON XL INSTRUMENT FUNCTIONS (DISCONTINUED).....	92
7.14.1 Basic System Functions	92

7.15 COLOR EFIS + AVIATION GPS (STRATOMASTER ENIGMA), (DISCONTINUED).....	93
7.15.1 General Wiring Hook-Up Diagram	93
7.15.2 Glass Panel (Enigma) Start-Up Quick Reference.....	94
7.15.3 Screens 1 through 5	95
7.15.4 Common EFIS GPS Usage	101
7.15.4.1 List of Closest Airports and Activating Airports Database	101
7.15.4.2 How to Use Airports Database Browser or Search for Airport by Identifier	102
7.15.5 EFIS COM Radio Control	103
7.5.5.1 Using the “Radio” Page to Set Frequencies Not Related to an Airport	104
7.15.6 SP-2 Magnetic Compass Heading Navigation and Calibration	104
7.16 XTREME EFIS (STANDARD EQUIPMENT).....	107
7.17 EXPLORER 8.5” iEFIS (OPTION FOR 912UL, ULS AND iS).....	109
7.18 SECONDARY ENGINE KILL IGNITION SWITCH FOR THE BACK SEAT	110
7.19 BALLISTIC RECOVERY SYSTEMS – PARACHUTE (OPTIONAL).....	110
8 HANDLING, SERVICING AND MAINTENANCE	111
8.1 INTRODUCTION	111
8.2 IDENTIFICATION PLATES	111
8.3 DOCUMENTS	111
8.4 AIRCRAFT INSPECTION, MAINTENANCE AND REPAIR	112
8.4.1 Hangbolt Replacement	112
8.4.2 Mast Bolts and Nuts Replacement	112
8.4.3 Engine Mount Bolts and Nuts Replacement	112
8.4.4 Wing Hardware Replacement	112
8.4.5 Wing Sail Condition	113
8.4.6 Propeller	113
8.5 FUEL SYSTEM	113
8.6 ENGINE OIL REPLENISHMENT	113
8.7 ENGINE COOLANT REPLENISHMENT	113
8.8 TIRE PRESSURES	113
8.9 HYDRAULIC BRAKE FLUID	113
8.10 FRONT SHOCK ABSORPTION	113
8.11 ELECTRICAL CIRCUIT BREAKERS AND BATTERY	114
8.12 PARKING, MOVING ON THE GROUND AND STORAGE	114
8.13 TRANSPORTING THE AIRCRAFT	115
8.14 CLEANING	115
8.14.1 Windshield	115
8.14.2 Painted Surfaces	115
8.14.3 Engine	115
8.14.4 Propeller	116
8.14.5 Upholstery and Interior	116
8.15 APPROVED SOURCES OF INFORMATION AND MAINTENANCE	116
9 SUPPLEMENT	117
9.1 PLACARDS	117
10 DATA LOCATION AND CONTACT INFORMATION	118
11 SETUP AND BREAKDOWN	118
12 FLIGHT TRAINING SUPPLEMENT.....	118
12.1 DISCOVERY 13.5 WING.....	118
12.2 REFLEX SPORT 12.5 WING.....	118
12.3 COMPETITION 11 WING.....	119
12.4 RIVAL (discontinued)/ RIVAL S 12.4 WING.....	120
12.5 RIVAL X 14.0 WING.....	121

1 GENERAL

This ASTM compliant Aircraft Operating Instructions (AOI)/ Pilot Operating Handbook (POH) is designed for maximum utilization as an operating guide for the pilot. It includes the material required by the regulations to be furnished to the pilot. It also contains supplemental data supplied by the aircraft manufacturer.

This Aircraft Operating Instructions / Pilot Operating Handbook is not designed as a substitute for adequate and competent flight instruction, knowledge of current airworthiness directives, applicable air regulations or advisory circulars. It is not intended to be a guide for basic flight instruction or a training manual and should not be used for operational purposes unless kept in a current status.

The remainder of the Aircraft Operating Instructions / Pilot Operating Handbook will be referred to as the Aircraft Operating Instructions or AOI.

Assurance that the aircraft is in an airworthy condition is the responsibility of the owner. The pilot in command is responsible for determining that the aircraft is safe for flight. The pilot is also responsible for remaining within the operating limitations as outlined by instrument markings, placards, and this AOI.

Maintenance of the aircraft is very important for safety. Proper and scheduled maintenance will promote longevity of the aircraft and most importantly trouble free flying.

Although the arrangement of this Aircraft Operating Instructions Manual is intended to maximize its in-flight capabilities, it should not be used solely as an occasional operating reference. The pilot should study the entire Aircraft Operating Instructions to become familiar with the limitations, performance, normal and emergency procedures and operational handling characteristics of the aircraft before flight.

The Aircraft Operating Instructions has been divided into numbered (Arabic) sections. The limitations and emergency procedures have been placed ahead of the normal procedures. The "Emergency Procedures" section is quickly available to present an instant reference. This Aircraft Operating Instructions has made provisions for expansion and/or updates.

Before flying the aircraft read and familiarize yourself with this AOI, Flight Training Supplement (FTS), Wing Manual, Engine Operators Manual and Maintenance Manual (MIP).

WARNING

Evolution Aircraft Inc. manuals may be revised in the future and safety directives may be issued for the aircraft. Hence, it is imperative that owners register their aircraft with Evolution Aircraft Inc. and promptly notify Evolution Aircraft Inc. of any changes to their contact details in writing. Owners registered on Evolution Aircraft Inc.'s database will be notified of safety directives and directed to Evolution Aircraft Inc.'s distribution web site for details (<http://www.evolutiontrikes.com/>) for the applicable information. It is owner's responsibility to keep abreast of all safety of flight issues for the aircraft. It is required that the owner checks this website for updates and notices and acts accordingly.

1.1 Introduction

The Revo has been designed and manufactured in accordance with the Weight Shift Control ASTM Consensus Standards as follows:

- F2317/F2317 M-10 Design and Performance & Required Equipment
 - F2447-05 Production Acceptance Tests
 - F2483-12 Maintenance and Inspection Procedures
 - F2425-05a Continued Airworthiness
 - F2972-12 Quality Assurance
 - F2339-06 Design & Manufacture of Reciprocating Spark Ignition Engines
- F2316-12 Airframe Emergency Parachutes (only if equipped with BRS)

This manual follows the product information required and format listed under ASTM standard F2457-05.

WARNING

The operator must be thoroughly familiar with the aircraft and the contents of this manual before initial operation.

Regular maintenance is required to keep your aircraft flying in a safe condition. Detailed maintenance requirements are outlined in the Maintenance Manual (MIP). Please reference these manuals to ensure your aircraft is maintained properly.

The operating procedures contained in this handbook are derived from experience and testing of this model of aircraft.

1.2 Definitions, Terminology and Abbreviations

This is not a complete set of definitions. It is assumed that the audience of this manual is already a trike pilot or pilot in training. Only those items and terminology that may not be covered sufficiently in a Sport Pilot – Weight Shift Control (SP-WSC) pilot training regimen are expanded upon here. This is **not** a replacement for proper training or ground school with your instructor.

Weight-Shift-Control: Powered aircraft with a framed pivoting wing and a fuselage, controllable only in pitch and roll by the pilot's ability to change the aircraft's center of gravity with respect to the wing. Flight control of the aircraft depends on the wing's ability to flexibly deform rather than the use of control surfaces.

Trim Speed: Indicated airspeed at which the aircraft remains in a stabilized condition without pilot input.

Sprog: Helps in dive recovery and pitch stability of the wing. This is a metal tube placed on the inside of the sail at about 70% out on the wing span on either wing. There can be multiple (two or more) sprogs in a topless wing

Definitions used in this handbook such as **WARNING**, **CAUTION** and **NOTE** employed in the following context.

WARNING

Procedures or instructions that if not followed correctly may result in injury or death.

CAUTION

Procedures or instructions that if not followed correctly may result in damage to the aircraft or its parts.

NOTE

Procedures or instructions that is essential to highlight.

Abbreviations:

AOA — Angle of Attack

AOB — Angle of Bank

AOI — Aircraft Operating Instructions

ATC — Air Traffic Control

FTS — Flight Training Supplement

MIP — Maintenance and Inspection Procedures

ELT — Emergency Locator Transmitter

FTS — Flight Training Supplement

BRS — Ballistic Recovery Systems

VFR — Visual Flight Rules

IFR — Instrument Flight Rules

AGL — Altitude Above Ground Level

C — Celsius

F — Fahrenheit

Hg — Mercury

CAS — Calibrated air speed

IAS — Indicated Air Speed (All airspeeds in AOI unless otherwise noted)

KIAS — Knots Indicated Air Speed

ISA — International Standard Atmosphere

Kg — Kilogram

km/hr — Kilometers per hour

MPH — Miles per hour

GPH — Gallons per hour

kt(s) — Nautical Mile per Hour (knot) (1 nautical mph = (1852/3600) m/s)

lb(s) — Pound(s) (1 lb = 0.4539 kg)

mm — Millimeter

cm — Centimeter

m — Meter

in — Inch

ft — Feet

sq m — Square Meter

sq ft — Square Feet

cu. in — Cubic Inches
cm³ — Centimeter Cube
mb — Millibars
N — Newton
Nm — Newton Meter
kW — Kilowatt
HP — Horse Power
RPM — Revolutions per Minute
ft. lbs — Foot Pounds
in. lbs — Inch Pounds
psi — Pounds per Square Inch gage pressure
s — Seconds
min — Minute(s)
hr(s) — Hour(s)
SI — International System of units
V_A — Maneuvering Speed
V_C — Operating Cruising Speed
V_{DF} — Demonstrated Flight Diving Speed
V_H — Maximum Sustainable Speed in straight and level flight
V_{NE} — Never Exceed Speed
V_{S0} — Stalling Speed, or the minimum steady flight speed in the landing configuration
V_{S1} — Stalling Speed, or the minimum steady flight speed in a specific configuration
V_x — Speed at which Best Angle of Climb is achieved
V_y — Speed at which Best Rate of Climb is achieved
V_T — Maximum Glider Towing Speed
TOSS — Take Off Safety Speed
Wsusp — Highest Trike Carriage Weight suspended under the wing
Wwing — Wing Weight
Wtkmt — Trike Carriage Empty Weight (including required minimum equipment, unusable fuel, maximum oil, and where appropriate, engine coolant, hangbolt and hydraulic fluid)
W_{MAX} — Maximum Design Weight (W_{wing} + W_{susp})
WSC — Weight Shift Control (aircraft)
SP WSC — Sport Pilot Weight Shift Control (aircraft)
Max — Maximum
Min — Minimum
MTOW — Maximum Take Off Weight

Units:

Speed:

1 Kts (Knots) = 1.15 mph (miles per hour) = 1.84 km/hr

1 km/hr = 1.6 MPH

Pressure:

PSI = Pounds per Square Inch

in Hg = inches of Mercury

mb = millibar

Distances:

1 in. = inches = 25.4 millimeters

1 ft = foot (feet) = .305 meters

Weights:

1 Kg = kilograms = 2.2 lbs = 2.2 pounds

Miscellaneous:

1 Pound (lb) = 0.4536 Kilogram (kg)

1 Pound per sq in (psi) = 6.895 Kilopascal (kPa)

1 Inch (in) = 25.4 Millimeters (mm)

1 Foot (ft) = 0.3048 Meter (m)

1 Statute mile = 1.609 Kilometers (km)

1 Nautical mile (NM) = 1.852 Kilometers (km)

1 Millibar (mb) = 1 Hectopascal (hPa)

1 Millibar (mb) = 0.1 Kilopascal (kPa)

1 Imperial gallon = 4.546 Liters (I)

1 US gallon = 3.785 Liters (I)

1 US quart = 0.946 Liter (I)

1 Cubic foot (ft³) = 28.317 Liters (I)

1 Degree Fahrenheit (F) = (1.8 X C)+32

1 Inch Pound (in lb) = 0.113 Newton Meters (Nm)

1 Foot Pound (ft lb) = 1.356 Newton Meters (Nm)

1.3 General Description

1.3.1 Carriage

Please refer to section 7 of the AOI for a general description of the Revo trike carriage.

1.3.2 Wings

Evolution Aircraft Inc.’s Revo is available with the following wings:

1. Discovery 13.5m
2. Rival S 12.4m
3. Rival X 14.0m
4. Competition 10.9m
5. Sport (discontinued) 12.5m
6. Reflex Rival (discontinued) 12.4m

Please refer to section 7 of the AOI, Wing Manuals and Flight Training Supplement (FTS) for detailed information on each wing.

NOTE

Manufacturer may approve the use of other certified wings for use with the Revo. This written approval must be attached to the AOI with a list of changes to relevant sections of the manual.

1.3.3 Engines

Revo is available with the following ASTM complaint engines:

1.3.3.1 Rotax 912UL



Version		Performance			Torque			Max RPM
		kW	HP	RPM	Nm	ft. lb.	RPM	RPM
912 UL2		58.0	79	5500	103	75.9	4800	5800
Max 5 min (take-off)		59.6	81	5800				
Bore		Stroke		Displacement			Compression Ratio	
79.5 mm	3.13 in.	61 mm	2.4 in.	1211.2 cm ³		73.91 cu. in.	9.0:1	

1.3.3.2 Rotax 912ULS



Version		Performance			Torque			Max RPM
		kW	HP	RPM	Nm	ft. lb.	RPM	RPM
912 ULS2		69.0	95	5500	128	94	5100	5800
Max 5 min (take-off)		73.5*	100*	5800*	* with Rotax airbox & exhaust system			
Bore		Stroke		Displacement		Compression Ratio		
84 mm	3.31 in.	61 mm	2.4 in.	1352 cm ³	82.6 cu. in.	10.5:1		

1.3.3.3 Rotax 912iS



Version		Performance			Torque			Max RPM
		kW	HP	RPM	Nm	ft. lb.	RPM	RPM
912 ULS2		69.0	95	5500	128	94	5100	5800
Max 5 min (take-off)		73.5*	100*	5800*	* with Rotax airbox & exhaust system			
Bore		Stroke		Displacement		Compression Ratio		
84 mm	3.31 in.	61 mm	2.4 in.	1352 cm ³	82.6 cu. in.	10.5:1		

1.3.4 Propellers

The Revo uses the following props:

1.3.4.1 Warp Drive

Warp Drive is a composite propeller with an Aluminum hub and AN hardware. It is a 3-blade 68” without nickel leading edge. It comes with a simple way to set the pitch on the ground. The acceptable pitch range is specified at the factory and marked on the propeller.

1.3.4.2 Sensenich Propeller for the Rotax 912 Series Engines

Sensenich is a 2-blade (69” or 72”) composite propeller both with an aluminum hub specifically designed for Rotax 912 series of engines. This prop is available as an option.

1.3.4.3 E-props Propeller for the Rotax 912 Series Engines

E-props is a 4, 5 or 6-blade composite propeller with a Carbon fiber hub or aluminum hub specifically designed for Rotax 912 series of engines. This prop is highly recommended for the 912iS due to its very low moment of inertia and available as an option on all 912 series motors.

CAUTION

No pitch change should be undertaken that can over speed the propeller (engine red line RPM) in normal flight, excluding dive at full power which can over speed the prop.

NOTE

A 4 inch spool spacer is used with each Revo to distance the prop blades from the carriage appropriately.

REVO aircraft starting at serial number #000595 have threaded holes in this spacer used for adding weight in various positions when dynamically balancing the prop. Different length bolts or set screws must be installed with thread lock such as Loctite 242.

1.3.5 Fuel

The following fuels are recommended for the Revo:

- **Lead Free 89 Octane or higher for 912UL (discontinued)**
- **Lead Free 91 Octane or higher for 912ULS and 912iS**
- **Avgas 100LL**

NOTE

Avgas 100LL is permitted. Due to higher lead content in AVGAS, the wear of the valve seats and deposits in the combustion chamber will increase. More frequent oil changes are necessary with use of Avgas. See Rotax manuals for further details.

1.4 Dimensions

	Metric		Imperial/US	
	Wing Span	Competition	8.23 m	Competition
Reflex Sport		9.6 m	Reflex Sport	31.5 ft
Discovery		9.6 m	Discovery	31.5 ft
Rival		9.0 m	Rival	29.5 ft
Rival S		9.0 m	Rival S	29.5 ft
Rival X		9.6 m	Rival X	31.5 ft
Wing Area	Competition	10.9 sq m	Competition	118.0 sq. ft
	Reflex Sport	12.5 sq m	Reflex Sport	134.5 sq. ft
	Discovery	13.5 sq m	Discovery	145.0 sq. ft
	Rival	12.4 sq m	Rival	134.0 sq. ft
	Rival S	12.4 sq m	Rival S	134.0 sq. ft
	Rival X	14.0 sq m	Rival X	150.6 sq. ft
Aspect Ratio	Competition	6.075:1	Competition	6.075:1
	Reflex Sport	7.37:1	Reflex Sport	7.37:1
	Discovery	6.8:1	Discovery	6.8:1
	Rival	6.2:1	Rival	6.2:1
	Rival S	6.2:1	Rival S	6.2:1
	Rival X	6.5:1	Rival X	6.5:1
Wing Weight	Competition	51.5 kg	Competition	114 lbs
	Reflex Sport	53.5 kg	Reflex Sport	118 lbs
	Discovery	54.5 kg	Discovery	120 lbs
	Rival	52.0 kg	Rival	116 lbs
	Rival S	52.0 kg	Rival S	116 lbs
	Rival X	54.9 kg	Rival X	121 lbs
Lowest Overall Trike Height	All wings	2.5 m	All wings	8.4 ft

	Metric		Imperial/US	
	Wing Length (Long Pack)	Competition	4.87 m	Competition
Reflex Sport, Discovery & Rival X		5.48 m	Reflex Sport, Discovery & Rival X	18 ft
Rival & Rival S		5.0 m	Rival S	16.5 ft
Wing Length (Short Pack)	All wings	3.6m	Competition	12 ft
Trike Width Outside to Outside including wheel pants	2 m		80"	
Trike Carriage Length including wheel pant fins	2.7 m		8.9 ft (107")	
Wheel Inside to Inside Width	1.46 m		4.8 ft (57.5")	

1.5 Views

1.5.1 Front



1.5.2 Side



1.5.3 Back



2 LIMITATIONS

2.1 General

The limitations section of this manual outlines the various operating limitations, instrument function and placards necessary for the safe operation of this aircraft, engine and standard equipment.

2.2 Airspeed Limitations

NOTE

All airspeeds are Indicated Airspeed (IAS) unless otherwise noted.

2.2.1 Competition 11

Speed	KIAS	Comments
V _{NE} ---Never Exceed Speed	100 Kts (115 MPH) (184 Km/hr)	Never exceed this speed in any operation
V _A ---Max. Maneuvering Speed at gross weight	78 Kts (90 MPH) (144 Km/hr)	Do not make abrupt or full control deflections above this speed or fly in extreme turbulence above this speed at gross weight.
V _{S0} --- Stalling Speed	38 Kts (44 MPH) (70 Km/hr)	

NOTE

V_{NE} ---Never Exceed Speed is and can be programmed as a limit in the digital ASI for the wing installed at the time of flight. V_A reduces with reduction in weight.

2.2.2 Reflex Sport 12.5 (discontinued)

Speed	KIAS	Comments
V _{NE} ---Never Exceed Speed	96 Kts (110 MPH) (176 Km/hr)	Never exceed this speed in any operation
V _A ---Max. Maneuvering Speed	69 Kts (80 MPH) (128 Km/hr)	Do not make abrupt or full control deflections above this speed or fly in extreme turbulence above this speed at gross weight.
V _{S0} --- Stalling Speed	34 Kts (39 MPH) (62 Km/hr)	

NOTE

V_{NE} ---Never Exceed Speed is and can be programmed as a limit in the digital ASI for the wing installed at the time of flight. V_A reduces with reduction in weight.

2.2.3 Discovery 13.5

Speed	KIAS	Comments
V _{NE} ---Never Exceed Speed	78 Kts (90 MPH) (144 Km/hr)	Never exceed this speed in any operation
V _A ---Max. Maneuvering Speed	64 Kts (74 MPH) (118 Km/hr)	Do not make abrupt or full control deflections above this speed or fly in extreme turbulence above this speed at gross weight.
V _{S0} --- Stalling Speed	33 Kts (38 MPH) (60 Km/hr)	

NOTE

V_{NE} ---Never Exceed Speed is and can be programmed as a limit in the digital ASI for the wing installed at the time of flight. V_A reduces with reduction in weight.

2.2.4 Rival 12.4 (discontinued)

Speed	KIAS	Comments
V _{NE} ---Never Exceed Speed	96 Kts (110 MPH) (176 Km/hr)	Never exceed this speed in any operation
V _A ---Max. Maneuvering Speed at gross weight	78 Kts (90 MPH) (144 Km/hr)	Do not make abrupt or full control deflections above this speed or fly in extreme turbulence above this speed at gross weight.
V _{S0} --- Stalling Speed	38 Kts (44 MPH) (70 Km/hr)	

NOTE

V_{NE} ---Never Exceed Speed is and can be programmed as a limit in the digital ASI for the wing installed at the time of flight. V_A reduces with reduction in weight.

2.2.5 RIVAL S 12.4

Speed	KIAS	Comments
V _{NE} ---Never Exceed Speed	100 Kts (115 MPH) (184 Km/hr)	Never exceed this speed in any operation
V _A --- Max. Maneuvering Speed at gross weight	78 Kts (90 MPH) (144 Km/hr)	Do not make abrupt or full control deflections above this speed or fly in extreme turbulence above this speed at gross weight.
V _{S0} --- Stalling Speed	38 Kts (44 MPH) (70 Km/hr)	

2.2.6 RIVAL X 14.0

Speed	KIAS	Comments
V _{NE} ---Never Exceed Speed	91 Kts (105 MPH) (169 Km/hr)	Never exceed this speed in any operation
V _A --- Max. Maneuvering Speed at gross weight	66 Kts (76 MPH) (122 Km/hr)	Do not make abrupt or full control deflections above this speed or fly in extreme turbulence above this speed at gross weight.
V _{S0} --- Stalling Speed	33 Kts (38 MPH) (61 Km/hr)	

NOTE

VNE ---Never Exceed Speed is and can be programmed as a limit in the digital ASI for the wing installed at the time of flight. Va reduces with reduction in weight. All figures above are shown at gross weight.

2.3 Engine Operating Limitations

2.3.1 Rotax 912UL

Engine Limitations	Metric	Imperial/US
ENGINE RPM		
Max RPM	5800 RPM (5 minutes max)	5800 RPM (5 minutes max)
Maximum Continuous RPM	5500 RPM	5500 RPM
Idle RPM	1800-2000 RPM	1800-2000 RPM
POWER DATA		
Takeoff Performance	59.6 KW	81 HP
Continuous Performance	58 KW	79 HP
OIL PRESSURE		
Maximum Oil Pressure (allowed for short period at cold start)	7 bar	102 psi
Minimum Oil Pressure (below 3500 RPM)	0.8 bar	12 psi
Normal Oil Pressure (above 3500 RPM)	2 – 5 bar	29 – 73 psi
OIL TEMPERATURE		
Maximum Oil Temperature	140° C	285° F
Minimum Oil Temperature (idle at 2000 for 2 minutes and proceed to 2500 RPM till minimum oil temperature is reached)	50° C	120° F
Normal Oil Temperature	88 - 110° C	190 - 230° F
CYLINDER HEAD/ WATER TEMPERATURES		
Maximum CHT/ H2O	150° C / 120° C	300° F / 248° F
Normal CHT/ H2O	75 - 110°C / 75 - 110°C	167 - 230° F / 167 - 230° F
EXHAUST GAS TEMPERATURE		
Maximum at max. Takeoff Power	880° C	1616° F
Maximum at max. Continuous Power	850° C	1560° F
Normal EGT	800° C	1472° F
FUEL PRESSURE		
Maximum Fuel Pressure	0.4 bar	5.8 psi
Minimum Fuel Pressure	0.15 bar	2.2 psi
AMBIENT OPERATING TEMPERATURE		
Maximum	50° C	120° F
Minimum	-25° C	-13° F

2.3.2 Rotax 912ULS

Engine Limitations	Metric	Imperial/US
ENGINE RPM		
Max RPM	5800 RPM (5 minutes max)	5800 RPM (5 minutes max)
Maximum Continuous RPM	5500 RPM	5500 RPM
Idle RPM	1800-2000 RPM	1800-2000 RPM
POWER DATA		
Takeoff Performance	73.5 KW	100 HP
Continuous Performance	69 KW	95 HP
OIL PRESSURE		
Maximum Oil Pressure (allowed for short period at cold start)	7 bar	102 psi
Minimum Oil Pressure (below 3500 RPM)	0.8 bar	12 psi
Normal Oil Pressure (above 3500 RPM)	2 – 5 bar	29 – 73 psi
OIL TEMPERATURE		
Maximum Oil Temperature	130° C	266° F
Minimum Oil Temperature (idle at 2000 for 2 minutes and proceed to 2500 RPM till minimum oil temperature is reached)	50° C	120° F
Normal Oil Temperature	90 - 110° C	190 - 230° F
CYLINDER HEAD / WATER TEMPERATURES		
Maximum CHT/ H2O	135° C / 120° C	275° F / 248° F
Normal CHT/ H2O	75 - 110°C / 75 - 110°C	167 - 230° F / 167 - 230° F
EXHAUST GAS TEMPERATURE		
Maximum at max. Takeoff Power	880° C	1620° F
Maximum at max. Continuous Power	850° C	1560° F
Normal EGT	800° C	1472° F
FUEL PRESSURE		
Maximum Fuel Pressure	0.4 bar	5.8 psi
Minimum Fuel Pressure	0.15 bar	2.2 psi
AMBIENT OPERATING TEMPERATURE		
Maximum	50° C	120° F
Minimum	-25° C	-13° F

2.3.3 Rotax 912iS

Engine Limitations	Metric	Imperial/US
ENGINE RPM		
Max RPM	5800 RPM (5 minutes max)	5800 RPM (5 minutes max)
Maximum Continuous RPM	5500 RPM	5500 RPM
Idle RPM	1550-1950 RPM	1550-1950 RPM
POWER DATA		
Takeoff Performance	73.5 KW	100 HP
Continuous Performance	69 KW	95 HP
OIL PRESSURE		
Maximum Oil Pressure (allowed for short period at cold start)	7 bar	102 psi
Minimum Oil Pressure (below 3500 RPM)	0.8 bar	12 psi
Normal Oil Pressure (above 3500 RPM)	2 – 5 bar	29 – 73 psi
OIL TEMPERATURE		
Maximum Oil Temperature	130° C	266° F
Minimum Oil Temperature (idle at 2000 for 2 minutes and proceed to 2500 RPM till minimum oil temperature is reached)	50° C	120° F
Normal Oil Temperature	90 - 110° C	190 - 230° F
WATER TEMPERATURE		
Maximum H2O	120° C	248° F
Normal H2O	75 - 110°C	167 - 230° F
EXHAUST GAS TEMPERATURE		
Maximum at max. Takeoff Power	880° C	1620° F
Maximum at max. Continuous Power	850° C	1560° F
Normal EGT	800° C	1472° F
FUEL PRESSURE		
Maximum Fuel Pressure	0.4 bar	5.8 psi
Minimum Fuel Pressure	0.15 bar	2.2 psi
AMBIENT OPERATING TEMPERATURE		
Maximum	50° C	120° F
Minimum	-25° C	-13° F

2.4 Engine Operating Media

Please refer to the Rotax Operator’s manual section for Operating media approved for your engine.

2.5 Fuel and Oil Capacity

2.5.1 Fuel Capacity

Fuel Capacity	Unusable Fuel Capacity
14.5 US Gallons (54.9 Liters)	1.3 US Gallons (4.9 Liters)
17.5 US Gallons (66.2 Liters) (OPTIONAL – NO BRS)	1.3 US Gallons (4.9 Liters)

2.5.2 Oil Capacity

Oil Tank Capacity (912 series engines)
3.12 Liters or 3.3 Quarts

NOTE

Revo models built after September 2013 are equipped with a Curtis quick drain oil system for draining the oil reservoir. This part is available for previous models.

2.6 Aircraft Operational and Maneuvering Limits

2.6.1 Center of Gravity Limits

Center of gravity limits in a flex wing, weight shift control aircraft are controlled by hang block position on the keel of the wing. The carriage attaches to the wing through this universal junction known as hang block. Variations in cockpit and fuel loading cannot affect aircraft's balance significantly for purposes of safety. The Revo is therefore not critical in terms of center of gravity. However, distribution of load in a trike carriage affects the attitude of the trike carriage in-flight in a minor way as long as prescribed weight limits per seat are followed which are 250 lb (113 kg) per seat max and 90 lb (41 kg) minimum pilot seat and 0 lb minimum passenger rear seat.

NOTE

The trike may optionally be equipped with an electric speed trim device that allows the pilot to change the trim position of the wing within limits to speed up or slow down the aircraft. In such a case it is advisable that pilots set their trim position in the center of the range for take-off and slow down the aircraft to proper approach speed using this trim during an approach to landing. If the electric speed trim is not set properly, it will require more pressure to slow the aircraft down when trimmed fast and more pressure to maintain higher air speed when trimmed slow which may be taxing to the body. Ultimately, the pilot controls the speed not the trim setting of the aircraft.

Base Suspension Range	Dimension (Metric -millimeters)	Dimension (Imperial/US -inches)
Competition (from front edge of nose keel tube of the wing to the center of the hangbolt)	1295 mm – 1397 mm	51” – 55”
Reflex Sport (from front edge of nose keel tube of the wing to the center of the hangbolt) (discontinued)	1346 mm – 1448 mm	53” - 57”
Discovery (from front edge of nose keel tube of the wing to the center of the hangbolt)	1397 mm – 1499 mm	55” – 59”
Rival (from front edge of nose keel tube of the wing to the center of the hangbolt (discontinued)	1270 mm- 1397 mm	50”-55”
Rival S (from front edge of nose keel tube of the wing to the center of the hangbolt)	1270 mm- 1397 mm	50”-55”
Rival X (from front edge of nose keel tube of the wing to the center of the hangbolt)	1320 mm- 1447 mm	52”-57”

2.6.2 Maneuvering Limits and Loads

WARNING
All aerobatic maneuvers including whip stalls, wingovers/wangs, loops, steep prolonged spiral descents, spins and any negative G maneuvers are prohibited.

These maneuvers can never be conducted with a guarantee of safety. These maneuvers can put the aircraft outside the pilots control and put both the aircraft and its occupants in extreme danger.

Do not pitch nose up or nose down more than 30° from the horizontal. The front support tube also known as the compression strut of the trike and the pilot’s chest limits the fore and aft movement of the control bar respectively. However, these limits control AOA in most positive G flight modes and have nothing to do with the nose up or down attitude the REVO is capable of achieving. Do not bank more than 60° angle of bank. Flying the REVO outside of these set parameters can lead to unrecoverable tumbles, excess G loads above 4Gs or exceed the aircraft’s VNE which can result in **DEATH**.

Limits	
Maximum Takeoff Weight	450 Kg, 992 lbs for microlight category in some European countries OR 472 Kg, 1040 lbs with Competition and Reflex Sport 482 Kg, 1060 lbs with Discovery and Rival 526 Kg, 1160 lbs with Rival S
Maximum Weight in Each Seat	114 Kg, 250 lbs
Minimum Weight in the Front Seat	41 Kg, 90 lbs
Pitch	+30°, -30° from Horizontal
Roll	+60°, -60° AOB
Maximum Positive Maneuvering Load Factor	+4.0 G
Negative Maneuvering Load Factors	Prohibited
Load Factors below 1.0 G	To Be Avoided

2.6.3 Minimum Flight Crew and Crew Weight

At least one pilot in the front seat is required to operate the aircraft. Minimum pilot weight is 90 lbs (41 kg) in the front seat.

WARNING
Always operate the aircraft from the front seat when flying solo.

2.6.4 Maximum Passenger Seating Limit

In addition to pilot in the front seat, a maximum of one passenger is allowed in the back seat. Maximum weight per seat is 250 lbs (113 kg) and a combination of pilot and passenger should not exceed maximum takeoff weight or gross weight of the aircraft.

2.6.5 Operating Limits

Limits	Allowed (Yes/No/Comment)
Day VFR operations	Yes
IFR operations	No
Night VFR operations	Only if properly equipped and with proper training from an authorized flight instructor depending on national civil aviation authority rules When the aircraft is equipped for night flying and the pilot has the relevant national license certifications for night flying in a trike, the machine is then authorized for night flying by the manufacturer. Evolution Aircraft, Inc. strongly recommends that the aircraft is kept within safe gliding distance of an airport with lighted runways for the entire duration of the flight.
Operations without engine monitoring Instruments.	No (EGT is not a required instrument by Rotax for 912 series engines)
Operation without proper training on this particular combination of trike and wing from a qualified instructor.	No
Operation without familiarity with this manual in full.	No
Takeoff with a wing known to have moisture or frost on it.	No. Moisture must be wiped off and dry before takeoff. Stall speed can become high with moisture on the leading edge of the wing. Frost can be more detrimental to the lift properties of a wing. Do NOT fly with frost on the wing!
Operation outside the CG limit trim set by the manufacturer.	No
Flight without helmet, visor or eye protection.	No Front seat eye protection not required if equipped with extra-large windscreen.
Low flying	Low flying is prohibited, even where permitted by local aviation law, unless the pilot has complete and recent knowledge of the area and obstacles in the vicinity.

Limits	Allowed (Yes/No/Comment)
Congested area safe altitude	This aircraft may only be operated over congested areas when a safe landing can be made without damage to aircraft or person, vessel, vehicle, structure or property on the ground in the event of an engine failure. Evolution Aircraft, Inc. recommends that the aircraft be flown as often as possible within safe gliding distance of a landing site.

2.6.5.1 Environmental Restrictions

Other Limitations	Value
Operation in continued medium to heavy rain	Not allowed
Maximum Crosswind Component	14 Kts (16 MPH) (26 Km/hr) see section 4.8.10 for additional clarification.
Maximum Wind Strength	23 Kts (26 MPH) (42 Km/hr)
Maximum Ambient Operating Temperature	50°C or 120° F (all temperatures have to monitored and power must be lowered to keep within limits while operating at the extremes of these temperatures).

WARNING
Moisture on the wing can increase the stall speed of the aircraft and all moisture should be removed prior to takeoff.

2.6.6 Minimum Equipment List

Equipment Reading Required	Comment
Engine monitoring instruments, if any required, for safe operation of the engine by the engine manufacturer.	Please consult the ASTM engine manual for most up-to-date information from the engine manufacturer. For Rotax 912 series engine, the following instruments are a minimum required: <ol style="list-style-type: none"> 1) Engine RPM 2) Oil Pressure 3) Oil Temperature 4) CHT

NOTE

Please refer to Appendix A for the particular trike that lists the equipment installed at the manufacturing facility for this aircraft. A letter of authorization from the manufacturer is required for any modifications from this list citing specific serial number of the aircraft lest the aircraft falls out of compliance and its status is lost as Special-Light Sport aircraft or Production-Light Sport Aircraft. If the aircraft is not certificated as Special Light Sport Aircraft with the FAA then changes can be made without any warranty, real or implied. However, the manufacturer is not liable for support or safe operation of the aircraft if changes are made to the aircraft.

3 Emergency Procedures

3.1 General

This section of the manual deals with procedures to be adopted during an abnormal event in the operation of the Revo weight-shift-control aircraft (trike).

Perform steps listed in the order listed unless warranted and determined by a qualified pilot in command (PIC).

It is important to maintain correct and suitable pattern altitude and speed for safe operation of the aircraft.

Never fly in adverse weather conditions and always fly within the limits of your skill and ability. Limit departures from your proven ability to instructional settings only under supervision of a qualified instructor acting as PIC of the aircraft.

Be aware of rotors and turbulence when flying near mountains or obstacles. Being on the wrong side of the mountain can make you experience extreme turbulence and down drafts that cannot be overcome even with full engine power in some cases. It is suggested to take further instruction and orientation regarding mountain flying from qualified and experienced instructors before venturing solo in such terrain. It may be best not to fly near mountainous terrain during days with high winds.

Safe flight requires that you be aware of possible emergency landing areas and diversions along your flight route. Engines can stop regardless of how reliably maintained they are. Most engine outs do not happen because of the fault of the engine, but because of auxiliary systems fault or errors on the part of the pilot. Never put your life in the hands of any engine.

Always scan for other aircraft. Always show your intentions and be courteous to other aircraft. It should be noted that the manufacturer cannot possibly foresee all conceivable circumstances. Some circumstances such as multiple or unlisted emergencies, flight into adverse weather etc. may require modification to these procedures. A thorough knowledge of the aircraft and its systems is thus required to analyze the situation correctly and to determine the best course of action for the PIC.

3.2 Airspeeds for Emergency Operation

Wing	Speed	Indicated Air Speed (IAS)
Competition	Maximum Maneuvering Speed (V _A) at gross weight	76 Kts (88MPH) (141 Km/hr)
Reflex Sport (discontinued)	Maximum Maneuvering Speed (V _A) at gross weight	68 Kts (78 MPH) (125 Km/hr)
Discovery	Maximum Maneuvering Speed (V _A) at gross weight	67 Kts (77 MPH) (124 Km/hr)
Rival (discontinued)	Maximum Maneuvering Speed (V _A) at gross weight	76 Kts (88MPH) (141 Km/hr)
Rival S	Maximum Maneuvering Speed (V _A) at gross weight	76 Kts (88MPH) (141 Km/hr)
Rival X	Maximum Maneuvering Speed (V _A) at gross weight	66 Kts (76MPH) (122 Km/hr)

3.3 Emergency Procedures Checklists

3.3.1 Engine Out on Climb Out

If the engine quits on climb out, pull the control bar in quickly and immediately until the nose of the trike is no higher than the attitude for minimum sink. Best glide or a steeper nose down attitude such as approach speed attitude may be required. The pilot must choose which is most appropriate. After lowering the nose as described, then proceed to:

- 1) Maintain Control
- 2) Maintain Airspeed – best glide speed or higher
- 3) Forced Landing (straight ahead if possible)

WARNING

If a minimum altitude of 496 ft (150 m) cannot be obtained, immediately pull the control bar in abruptly; this will help to maintain airspeed until the nose of the trike reaches a desired approach angle. Choose close to best glide speed while seeking a place to land immediately in front to you or slightly to the left or right. An altitude of 496 ft AGL (150 m) will allow an attentive pilot to be able to make a turn back to the runway but this should be practiced by the pilot while the engine is working to establish proper responses.

IT IS IMPERATIVE THAT CORRECT GLIDE SPEED BE ATTAINED AND MAINTAINED! DO NOT TURN BACK TO THE RUNWAY BELOW THIS ALTITUDE.

WARNING

For establishing best glide your attention is drawn to section [5.5](#) of this manual. Keep in mind that ‘best glide’ is NOT ALWAYS desirable in engine out on climb-out situation depending on runway length. Pilot should establish appropriate glide speed as necessary.

3.3.2 Engine Failure at Altitude

If the engine stops while operating at cruise or full power when the aircraft is well clear of the ground (496 ft or 150 m), proceed as follows:

- 1) Establish Glide Speed – use trim if available
- 2) Select Landing Area
- 3) Trim for Landing (if available)
- 4) Proceed to Landing Area

NOTE

For establishing best glide your attention is drawn to section [5.5](#) of this manual.

Check the following if attention can be shared between safely continuing a glide to the emergency landing site that has been picked:

- 1) Fuel Valve On
- 2) Ignition On
- 3) Choke Off

Carry on with the rest of emergency landing procedure as listed in this section.

If your REVO is equipped with a fuel injected 912 iS then switch the emergency switch on and attempt to restart. This will connect the battery as a power source for the fuel injection.

If your engine fails in flight, relax and maintain control while concentrating on correct emergency landing techniques.

Adopt a suitable glide speed. For example, if gliding with a tailwind, minimum sink speed would give you the longest glide and increase options. As a careful pilot, you should always fly in "a cone of safety", at sufficient altitude, with an understanding of the orientation of the wind. It is not enough to simply land on the area you have chosen. Do NOT forget to take into account the possible obstacles that you could discover only at the last minute (e.g. power lines, ditches etc...) and ground related and/or mechanical turbulence that may occur. Check that your seat belt and that of the passenger is securely fastened. The final approach should be preferably into the wind. With the onset of night the approach should be with the sun at the rear if possible. Your aircraft will be quiet, check that there is nobody on the ground. Make a short landing run if possible.

If you have time, you can try to start the engine again while in flight. Verify that the problem is not from a memory lapse: choke lever actuated, fuel valve accidentally off, ignition switches off... Remember, even if the engine starts again remain in the cone of flight safety while circling the landing site and maintaining a glide without turning your back on the area. Or land on the area initially considered or a close-by better option, to determine the possible origin of the engine failure **BEFORE** continuing the flight to your destination.

3.3.3 Stuck Throttle at Full Power (In Flight)

If the throttle should jam full open in flight, proceed as follows:

- 1) Maintain Control and Select a Suitable Landing Area.
- 2) Get Height with engine at full power. Adjust height and ground position to improve the outcome of a forced landing.
- 3) Increase Airspeed to keep the climb angle less than 30 degrees above the horizontal – use trim if available.
- 4) Ignition Off
- 5) Trim for Landing (if available)
- 6) Prepare for forced landing in chosen landing area.

3.3.4 Emergency Landings

Proceed as follows:

- 1) Maintain Control and Airspeed - nominated approach speed - use trim if available.
- 2) Throttle Closed
- 3) Ignition Off
- 4) Fuel Valve Off
- 5) Seat Belts Tight
- 6) Helmets Tight
- 7) Body parts inside seat frame
- 8) Contact ATC if necessary and if there is time to alert Position and Problem.
- 9) Turn ELT ON if equipped
- 10) Advise passenger on how to communicate position using radio if pilot is incapacitated.
- 11) Decide if using the BRS parachute (if equipped) is necessary, depending on extreme harsh terrain.
- 12) Trim for Landing (if available)

3.3.5 Engine Fire While In-Flight

If fire occurs while in-flight, the initial procedure would be to maintain control of the aircraft and evaluate the extent of the fire. This emergency is unlikely to occur but to avoid any further problems, use common sense and land the aircraft safely.

Proceed as follows:

- 1) Maintain Control
- 2) Fuel Valve Off
- 3) Full Throttle (To exhaust engine system fuel as soon as possible and maximize slipstream to clear flames from passengers and airframe).

When fuel is exhausted then:

- 1) Ignition off
- 2) Trim for Landing
- 3) Forced Landing
- 4) After landing Release seat belt
- 5) Release Passenger seat belt
- 6) Evacuate aircraft and step away from it

3.3.6 Engine Fire on Ground

If fire occurs while aircraft is moving on the ground, proceed as follows:

- 1) Maintain Control
- 2) Fuel Valve Off
- 3) Use remaining speed to clear people, other aircraft and property
- 4) Ignition Off
- 5) After stopping Release seat belt
- 6) Release passenger seat belt
- 7) Evacuate aircraft and step away from it

3.3.7 Propeller Damage

WARNING

Propeller blades are spinning at very fast speeds while cruising and at full power. Propeller tip speeds may reach 0.7 Mach and even small objects can cause significant damage to the propeller blades if thrown into the prop during normal or full power operation.

The indication of propeller damage is usually felt by extreme vibration and lack of thrust.

Proceed as follows:

- 1) Throttle Closed
- 2) Maintain Control
- 3) Find suitable emergency landing area
- 4) Trim for Landing (if available)
- 5) Forced Landing

Certain precautions prior to takeoff are extremely helpful in avoiding this problem. Inspect the strip or ground you are going to use as your take off area for anything that may kick up by the tires and go through the propeller.

In pre-engine start checklist always ensure that any loose items on the trike and yourself and passenger are secured so they can't go through the prop.

3.3.8 Sail Damage

If you discover damage to the sail during flight, the first procedure is to maintain control of the aircraft. If the sail damage is not impairing the flight characteristics of the aircraft, land at the nearest landing field to inspect the damage.

3.3.9 Ballistic Recovery Systems (Parachute) - Optional

<p style="text-align: center;">WARNING</p> <p>There is no guarantee of any kind that the BRS will always work in all circumstances of an emergency in saving the occupants life. It should be used as a measure of last resort only.</p>
<p style="text-align: center;">WARNING</p> <p>It is important to realize that the parachute once deployed will control the rate of descent but the pilot will not have any control over where the aircraft will land.</p>
<p style="text-align: center;">WARNING</p> <p>Remove the BRS safety pin before flight and REPLACE immediately after flight before exiting the trike in order to avoid accidental deployment.</p>

The emergency ballistic parachute is an option. See picture (page 40).

The parachute-operating handle is fitted with a safety pin. Remove this pin before each flight and replace the safety pin before exiting the aircraft. A force of approximately 30 lbs (13.5 Kg) pull on the actuating handle is required to positively activate the BRS rocket motor.

Pilot should brief the passenger on the BRS parachute release sequence prior to flight.

The parachute is only to be used in emergency situations as a last resort and when you are certain that:

- 1) Aircraft is above 300 ft (91.4m) AGL.
- 2) The aircraft has suffered structural damage to the extent that control is not possible.
- 3) The aircraft is in an irrecoverable situation/attitude where structural damage is likely to occur.
- 4) A forced landing is required with no suitable landing area due to harsh terrain.

Refer to the BRS manual and section 7.18 for additional information.

To operate the parachute, first kill the engine. If possible, wait for the propeller to stop spinning. Then pull the handle at least 8 in (20 cm) for the parachute rocket projectile to be activated. The parachute will allow the complete aircraft to be lowered to the ground.

Proceed as follows:

- 1) Ignition/ Engine Off
- 2) Seat Belts Tight
- 3) Check parachute Pin Removed
- 4) Deploy parachute (pull with about 30 lbs/13.5 kg of force)
- 5) Safety Position Assume
- 6) Fuel Valve Off (if possible)

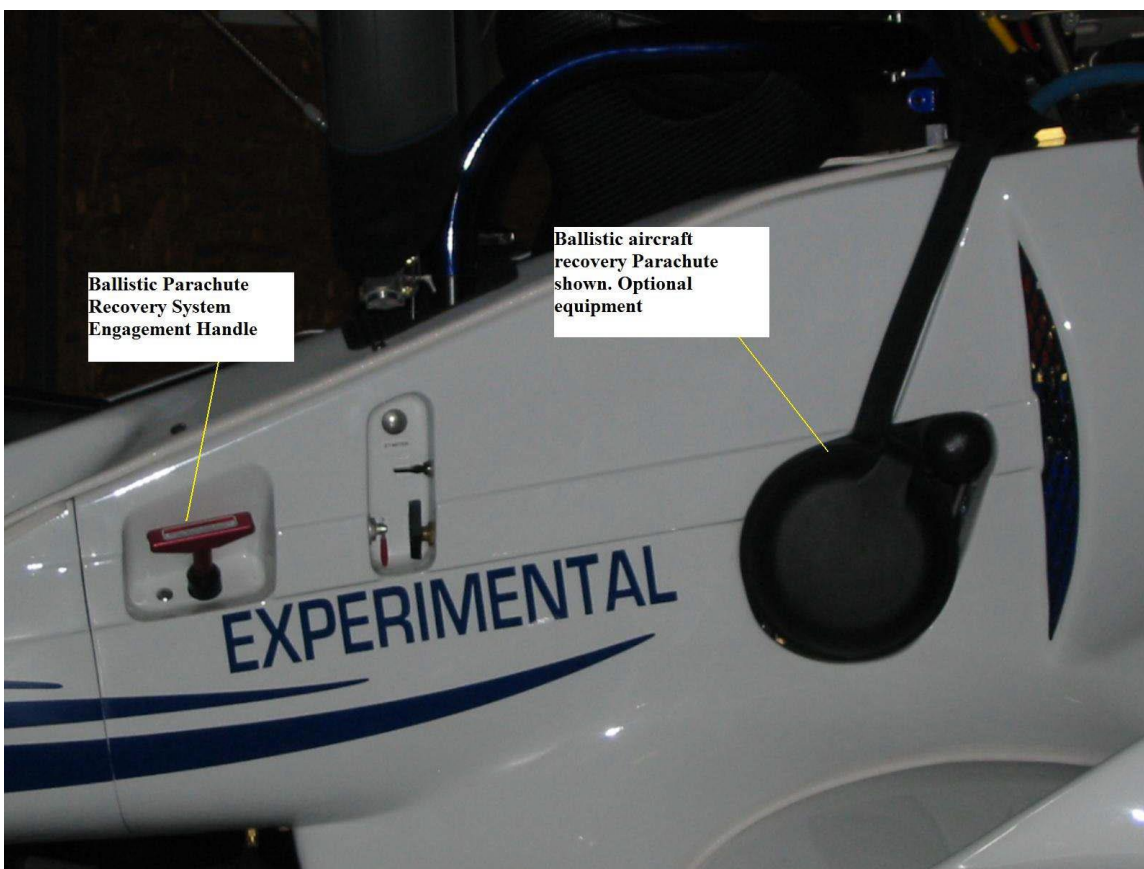

For additional information, refer to section 7.15.

3.3.10 Ignition Circuit Failure

The Rotax engine requires a hot circuit on the engine to kill the engine. If the ignition circuit for the pilot is broken it is possible to utilize the rear engine kill switch located on the port side of the aircraft accessible by both pilot and passenger.

It is possible to starve the engine by switching off the fuel valve - this method is not as quick however.

3.3.11 Spins and Spiral Descents

WARNING
No deliberate spin attempts are permitted.
Tight Spiral Dives should not be attempted.
During descending turns aircraft attitude should be kept within operating limitations for pitch, roll and airspace.

Any attempt at deliberate spinning of the aircraft is prohibited. After a stall, a spiral dive may develop if the bar remains in the forward limit and fast roll rate develops or continues. If this condition is not corrected it will lead to large and increasing bank attitudes (beyond the 60° limit). Increasing banked attitude, increasing speed and large control bar feedback will occur. Spiral dives can be terminated any time by pulling the bar in reducing the bar pressure and then rolling the wings level. If the spiral dive is allowed to develop to extreme bank attitude, recovery is helped by relieving the control bar forces (pulling the bar in slightly) and then rolling wings level and recovering from the high speed condition.

3.3.12 Unusual Attitudes

Unusual attitudes where the nose is raised or lowered more than 30° from the horizontal are to be avoided. On recognizing a situation where the aircraft is approaching these pitch angles proceed as follows:

3.3.12.1 Nose High Attitude

To recover from the situation where the nose of the aircraft pitches up more than 30° from the horizontal proceed as follows:

- 1) Reduce Power Appropriately
- 2) Pull the Control Bar In
- 3) The aircraft will rotate nose down
- 4) Once the nose lowers Increase Power to prevent over pitching
- 5) Recover and Resume desired flight path

3.3.12.2 Nose Down Attitude

To recover from the situation where the nose of the aircraft pitches down more than 30° from the horizontal proceed as follows:

- 1) Raise Attitude - push Out (as long as the wings are not banked greater than 30°, otherwise follow spiral dive recovery).
- 2) Apply Power if airspeed is below maneuvering speed.
- 3) Recover from Dive and Resume desired flight path.

3.3.13 Instrument Failure or Warnings

Instrument failure may happen through an electrical fault or through exposure to High Intensity Radio Fields (HIRF).

The aircraft is equipped with a digital engine and flight management and monitoring system. **If there is a problem with the digital system or a warning for fuel or any engine monitoring parameters is flashing** along with the red lighted “Warning” lamp on the switch plate, the **correct procedure is to try and fly to the nearest safe landing area, execute a precautionary emergency landing** and investigate the cause of the malfunction. Correct the problem before flying again.

If you get to **V_{NE} or other flight parameter danger situation warning** you may also get a flashing warning about **AIRSPEED** and similar **until you correct the situation**. In such cases **correct the flight situation that you have exceeded (AIRSPEED in this example) and continue normal flight** to the airport.

WARNING

Heed the flashing warnings on the EFIS system for engine monitoring parameters or low fuel and follow the recommended procedures. Use a conservative approach for safety. Always carry enough fuel to have a 45 min reserve upon landing. The EFIS will give you a warning when you get to the last 2.7 US gallons of fuel or reserve.

3.13.13.1 Course of Action for Engine Monitoring and Low Fuel Warnings

Included below are some pictures of what these flashing warnings on the EFIS look like. Familiarize yourself with these warnings. These pictures shown are on the Enigma Color Glass EFIS but the same warning labels will appear on the standard grey scale Stratomaster Ultra XL EFIS as well. The suggested courses of action are manufacturer’s recommendations. Use common sense and conservative approach and keep your situational awareness high. **Pilot in Command is ultimately responsible to make decisions that will lead to safe outcomes.**

3.13.13.1.1 CHT High



- Reduce throttle.
- Locate a safe landing area.
- Increase airspeed to increase airflow over the engine. Set trim if available.
- Set trim for landing (if available)
- Execute precautionary landing unless coolant temperature comes below the red line and remains there. In that case, continue flight and land at the closest airport to evaluate the problem.

3.13.13.1.2 Oil Temperature At or Above Red Line



- Reduce throttle.
- Locate a safe landing area.
- Increase airspeed to increase airflow over the engine. Set trim if available
- Set trim for landing (if available)
- Execute precautionary landing unless oil temperature comes below the red line and remains there. In that case, continue flight and land at the closest airport to evaluate the problem.

3.13.13.1.3 Fuel Level Warning

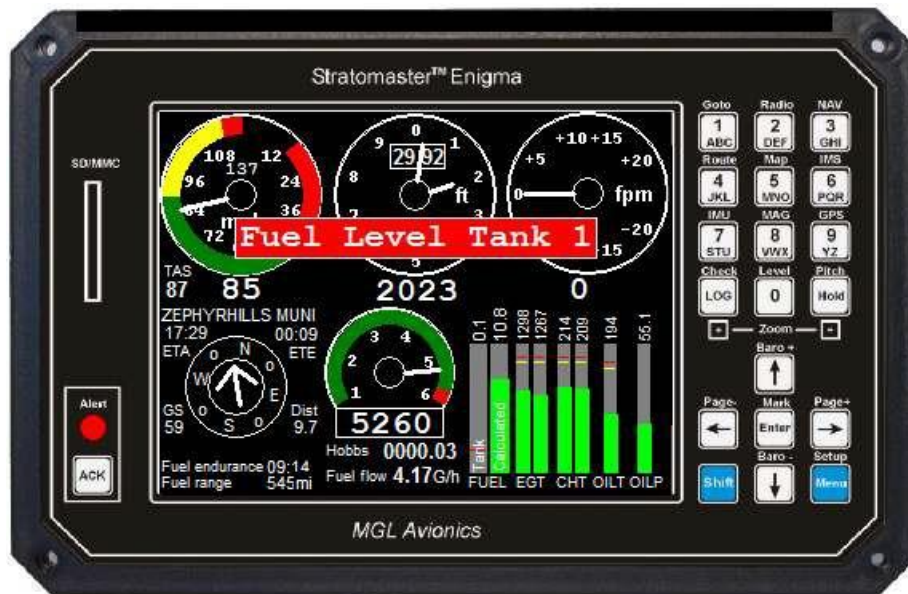

- If the fuel level warning has just started flashing, you are dipping into the reserve or last 45 minutes of flight fuel level. Evaluate if this warning makes sense to you compared to your flight planning (time and fuel usage calculation). As PIC it's your responsibility to carry enough quantity of fuel for safe flight and know your fuel usage and flight conditions.
- Continue the flight to the closest safe landing site.
- Set trim for landing (if available)
- Execute precautionary landing.

3.13.13.1.4 Oil Pressure Warning



- Reduce throttle.
- Locate a safe landing area.
- Set trim for landing (if available)
- Execute precautionary landing to evaluate the problem.

4 Normal Procedures

4.1 General

This section of the manual describes procedures for normal operations of this aircraft.

4.1.1 Speeds for Normal Operation

NOTE

All airspeeds are Indicated Airspeed (IAS) unless otherwise noted.

4.1.1.1 Competition 11

Trim Speed	52 – 79 Kts (60 – 90 MPH) (96 – 145 km/hr)
Stall Speed at Maximum Take Off Weight	37 Kts (43 MPH) (69 Km/hr)
Take Off Safety Speed - TOSS	54 Kts (62 MPH) (99 Km/hr)
Maximum Speed in Turbulence (V _A)	75 Kts (86 MPH) (138 Km/hr)
Maximum Level Speed (V _H)	92 Kts (106 MPH) (170 Km/hr)
Maximum wind operating conditions (At ground level)	23 Kts (26 MPH) (42 Km/hr)
Maximum Crosswind Component	14 Kts (16 MPH) (26 Km/hr)

4.1.1.2 Reflex Sport 12.5

(discontinued)

Trim Speed	48 – 77 Kts (55 - 88 MPH) (88 – 141 km/hr)
Stall Speed at Maximum Take Off Weight	34 Kts (39 MPH) (62 Km/hr)
Take Off Safety Speed - TOSS	48 Kts (55 MPH) (88 Km/hr)
Maximum Speed in Turbulence (V _A)	64 Kts (74 MPH) (118 Km/hr)
Maximum Level Speed (V _H)	92 Kts (106 MPH) (170 Km/hr)
Maximum wind operating conditions (At ground level)	23 Kts (26 MPH) (42 Km/hr)
Maximum Crosswind Component	14 Kts (16 MPH) (26 Km/hr)

4.1.1.3 Discovery 13.5

Trim Speed	52 – 69 Kts (60 - 80 MPH) (96 – 128 km/hr)
Stall Speed at Maximum Take Off Weight	33 Kts (38 MPH) (60 Km/hr)
Take Off Safety Speed - TOSS	41 Kts (48 MPH) (76 Km/hr)
Maximum Speed in Turbulence (V _A)	64 Kts (74 MPH) (118 Km/hr)
Maximum Level Speed (V _H)	78 Kts (90 MPH) (144 Km/hr)
Maximum wind operating conditions (At ground level)	23 Kts (26 MPH) (42 Km/hr)
Maximum Crosswind Component	14 Kts (16 MPH) (26 Km/hr)

NOTE

All airspeeds are Indicated Airspeed (IAS) unless otherwise noted.

4.1.1.4 Rival 12.4 (discontinued)

Trim Speed	52 – 78 Kts (60 – 90 MPH) (96 – 160 km/hr)
Stall Speed at Maximum Take Off Weight	37 Kts (43 MPH) (69 Km/hr)
Take Off Safety Speed - TOSS	53 Kts (62 MPH) (100 Km/hr)
Maximum Speed in Turbulence (V _A)	75 Kts (86 MPH) (121 Km/hr)
Maximum Level Speed (V _H)	90 Kts (104 MPH) (167 Km/hr)
Maximum wind operating conditions (At ground level)	23 Kts (26 MPH) (42 Km/hr)
Maximum Crosswind Component	14 Kts (16 MPH) (26 Km/hr)

4.1.1.5 Rival S 12.4

Trim Speed	61 – 87 Kts (70 – 100 MPH) (96 – 160 km/hr)
Stall Speed at Maximum Take Off Weight	37 Kts (43 MPH) (69 Km/hr)
Take Off Safety Speed - TOSS	53 Kts (62 MPH) (100 Km/hr)
Maximum Speed in Turbulence (V _A)	75 Kts (86 MPH) (121 Km/hr)
Maximum Level Speed (V _H)	90 Kts (104 MPH) (167 Km/hr)
Maximum wind operating conditions (At ground level)	23 Kts (26 MPH) (42 Km/hr)
Maximum Crosswind Component	14 Kts (16 MPH) (26 Km/hr)

4.1.1.6 Rival X 14.0

Trim Speed	52 – 78 Kts (60 –90 MPH) (96 – 144 km/hr)
Stall Speed at Maximum Take Off Weight	33 Kts (38 MPH) (61 Km/hr)
Take Off Safety Speed - TOSS	53 Kts (62 MPH) (100 Km/hr)
Maximum Speed in Turbulence (V _A)	66 Kts (76 MPH) (122 Km/hr)
Maximum Level Speed (V _H)	82 Kts (95 MPH) (152 Km/hr)
Maximum wind operating conditions (At ground level)	23 Kts (26 MPH) (42 Km/hr)
Maximum Crosswind Component	14 Kts (16 MPH) (26 Km/hr)

4.1.2 Normal Procedures Check List

This section provides comprehensive information regarding normal operations of this aircraft and assumes the pilot has proper training in the assembly and use of a weight shift controlled aircraft by a qualified instructor.

Pilot-In-Command (PIC) has the ultimate responsibility for determining if the aircraft is in a safe condition for flight. Pre-flight inspections, post-flight inspections and securing the plane all fall on the PIC. Unlike the highway, there is no place to pull over and remedy an unsafe problem once you are flying. Use of common sense, conservative approach and sound Aeronautical Decision Making (ADM) will help you enjoy flying for a long time.

4.2 Wing Assembly Procedure

Please refer to the wing manual for the assembly procedure.

4.3 Wing Pre-Flight Inspection

The design of the wing is such that junctions not open to view may be reached from zipped inspection panels. Start at the A-frame or control frame of the right wing and move around the wing making the following checks. Familiarize yourself with the wing so your pre-flights are effective and orderly.

Wing Pre-Flight Inspection	
Start with the Right Wing	
1) Downtube/strut/ control bar connection secure	√
2) Front and rear lower rigging cables secure, fray and corrosion free	√
3) Downtube not kinked or damaged	√
4) Hang block bolts all secure	√
5) Hang block backup cable secure	√
6) Leading edge tube undamaged and no dents or irregularities	√
7) Wing struts and joints inspected for any damage and all safety pins	√
8) Leading edge tube and cross-tube junction area inspected and secure	√
9) Inboard sprog secure and properly stationed (open inspection zipper)	√
10) Outboard sprog secure and properly stationed (open inspection zipper)	√
11) Wingtip batten secure, wing tip webbing secure	√
12) Leading edge tube inspected from the wing tip opening, condition good, no bends or abnormalities noticed.	√
13) Battens secure and pockets free from damage	√
14) Trailing edge sail condition good, no damage	√
15) Upper sail condition good	√
16) Haulback cable secured. Haulback bracket in good condition	√
Repeat for Left Wing	√
17) A-frame/ Control frame cables secure	√
18) A-frame/ Control frame Locked	√
19) Nose area (plates), bolts, nuts secure and swan catch and bracket in good shape. No cracks.	√
General Extended	
20) All Inspection zippers secure	√
21) Sail condition inspection	√
22) Sail free from water accumulation	√
23) Full / free movement of the wing when attached to the trike base to be completed before flight.	√
24) Inspect all cables. Inspect for kinks fraying, corrosion, particularly around the NICO press fittings on cable assemblies	√
25) The symmetry of the wing (Batten profile check). Stand back a distance and look at the wing from behind while tied to the front strut.	√
26) All sail seams intact, with no frayed stitching	√
27) Nose cone centered and secured properly	√

4.4 Attaching Wing to Trike Carriage

Attaching Wing to Carriage
1) Make sure that the ignition/ engine is off.
2) Remove wind shield using quick release snap fittings securing the windshield.
3) Position the wing on its A-frame, facing into the wind, with the nose on the ground.
4) Release the mast swivel locking bolt located on the mast behind the back seat. To access this bolt on the Revo, remove the back seat backrest which requires removal of two quick release pins (see picture) or un-Velcro if the Revo is equipped with the full engine enclosure.
5) CAUTION! Strap the rear seat belt around the pilot seat back holding it in the up position to act as a stop against the mast in case the mast is dropped during this procedure. This will protect the mast from being able to impact the instrument panel.
6) Pull the 2 quick release pip pins out of the slider joining tube of the compression strut and slide the tube up on the front strut. Place one quick pin in the lower compression strut hole to act as a stop in a later step. Now this strut can hinge forward while the mast lowers and the wing is ready to be attached to the carriage. (see photo pages 50 & 51)
7) Roll the trike behind the wing, and roll the front wheel over the control bar and center it as well as carefully keep the trike perpendicular to the wing.
8) Allow the mast tube to rise slightly until high enough to connect the hang block to the wing. Insert the hang bolt with bolt head retaining unit. Tighten nut firmly by hand and secure with safety pin.
9) Secure the backup safety cable.
10) Gently roll the trike carriage backwards so that the control bar is now just in front of the trike front wheel.
11) Let the wing keel area rest on the back of the mast. This also provides leverage when raising the wing and mast up and eliminates the need for using the parking brake during this procedure. Parking brake however can be engaged if desired at this point but will serve little benefit if this is done on level ground.
12) Squat on the ground and lift the wing by the control bar, making sure the A-frame is centered and not rubbing against the trike fairing.
13) After lifting the wing approximately 18" you will begin to feel the leverage provided by the mast pivot geometry and it will be easy to lift the wing the rest of the way.
14) Once the wing is totally lifted as high as possible, slide the slider joining tube over the front strut plastic hinge down to the speed pin temporarily acting as a stop.
15) At this point mast should be secured with the large ½" mast bolt into the mast bracket
16) Slide the compression strut sleeve back up to relieve the tension on the lower compression strut bracket and pull the speed pin. Fold the compression strut far enough to guide the lower section through the A frame and reconnect it to the trike carriage. Pull the speed pin and line up both holes of the slider and re insert both speed pins in the slider.
17) Install the windshield back with quick snap-ins. (Note - line the slots up horizontally and push)

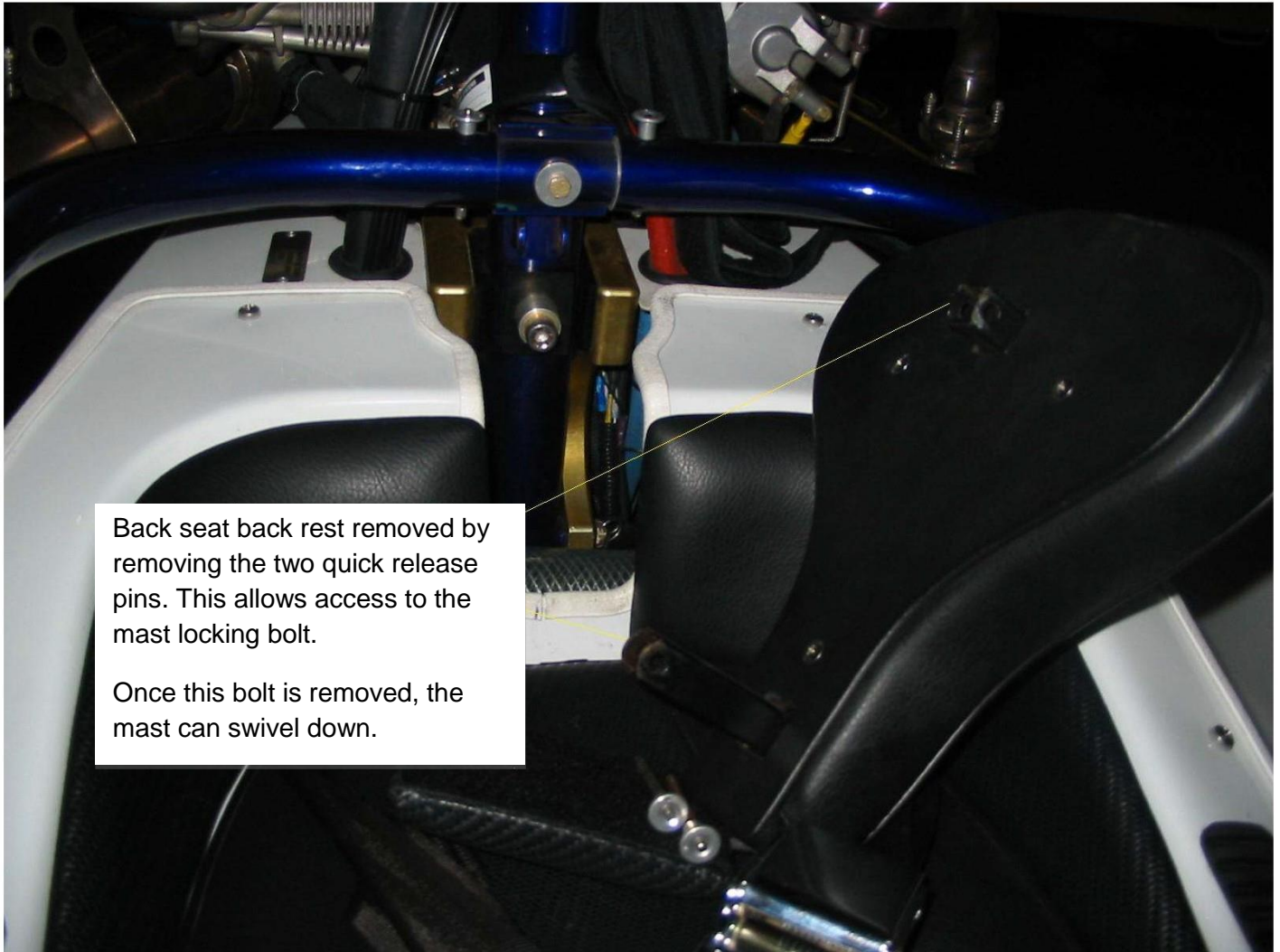



4.5 Complete Trike Carriage Pre-Flight Inspection

Ensure that the ignition switches are off prior to inspection. Daily inspections as outlined in the Rotax Engine Operator's Manual should be carried out in conjunction with the following inspections.

Trike Carriage Pre-Flight Inspection	
1) No hydraulic, oil or coolant leaks visible	√
2) Check oil level. Remove rear grill with quick fasteners and oil tank is accessible there.	√
3) Fuel vent line unobstructed	√
4) Check fuel level present for flight. Check gas in a clear container for contamination/water via fuel drain(s) (gascolator and tank drain both) under the belly	√
5) Fuel shut-off valve in the ON position	√
6) Check coolant level in tank and coolant present in overflow bottle between max and min marks	√
7) Check propeller blades and hub for nicks, cracks and de-laminating and bolts and nuts secure	√
8) Check exhaust system for proper alignment, affixed securely and any cracks etc.	√
9) All engine components secure - air filter, plug leads, etc.	√
10) Check tire tread, air in tires (18-25 psi)	√
11) Check main wheel pants secure (these commonly can loosen up and require 242 Loctite on all 4 bolts holding them.	√
12) No bolts and nuts fractured or cracked.	√
13) Mast locking bolt secured. Mast condition. Backrest, seat cushions and arm rests secured	√
14) Electrical system operational. Electric trim system operational	√
15) Foot throttle and cruise hand throttle operation	√
16) Seat belt condition good	√
17) Compression strut locking pins all secured	√
18) Hangblock secured to mast properly and bolts within it tight. Safety cable installed.	√
19) Mechanical Components. Rotate propeller in direction of rotation for about half a turn and observe for noise.	√
20) Front fork area checked for general condition (adjust front forks for pilot's height if necessary)	√
21) Parachute if attached secure and cable and pull handle securely in place	√
22) Wind shield secured	√
23) Verify throttle at idle by checking throttle position at carbs	√
24) General inspection of trike complete	√

4.6 Fueling

<p style="text-align: center;">WARNING Make sure the aircraft is GROUNDED while fueling.</p>
--

Fuel flow is from a single fuel tank fitted with a self-venting tube vented behind and at the bottom side of the trike and labeled. The fuel system is fitted with a shut off valve. Be sure this valve is in the **ON** position before starting engine.

Never refuel if fuel could be spilled on hot engine components. Use only approved fuel containers. Never transport fuel in an unsafe manner.

4.6.1 Fuel Gascolator

The fuel system has a gascolator with a fuel filter inside, mounted between the fuel tank and the fuel shut off valve. This filter can be replaced or cleaned and should be checked for debris during inspection. Fuel gascolator can be seen when the rear section of the trike is removed. Only those filter elements or gascolators approved by the manufacturer may be used. Check the fuel on each pre-flight by emptying the gascolator in a clear jar.

4.6.2 Fuel Level

NOTE

Note fuel level on instrument panel and the sight fuel tube located on the side of the trike to determine how much fuel will be required to fill the tank.

Remember 13.2Gal (50L) of fuel should be considered usable in the standard tank and 16.2Gal (61.3L) usable in the optional larger fuel tank.

Revos with Serial #597 and after are equipped with a quick fill tank located underneath the rear seat. This is an additional option when fueling for high speed fueling at high-speed fuel pumps.

NOTE

Be sure to remove both fuel caps when fueling. Removal of the regular gas cap acts as a high-speed fuel vent.

The Revo series fuel levels are seen from the MGL Avionics EFIS fuel level installed on the panel or in the clear fuel line on the side of the machine. Fill the tank to full by filling the fuel sight gauge all the way to the top.

4.6.3 Fuel Vent

A fuel vent line is located on the tank and is guided/vented to the outside of the trike near the back on the bottom. Confirm there is no obstruction in this vent line before flight.

4.6.4 Quick Drain

The fuel tank has a Curtis CCA-1250 (Assembled 3Q05) Quick drain valve mounted at the belly of the trike (underneath, aft). The Curtis Quick drain hose can be used to drain the fuel completely if desired. Take a fuel sample from the tank as well to check for water.

4.7 Helmet, Ear and Eye Protection Requirement

The open cockpit of trikes exposes the occupants to the elements during flight and exposes them to objects outside of the aircraft in an emergency situation.

Helmets, ear and eye protection are required for occupants for protection from wind, light rain and strike by insects and so on. Helmets are also required for risk reduction during an emergency landing of the aircraft. Although the pilot is completely protected by the windscreen during flight, once on the ground or during takeoff and landing it is possible for wind/bugs etc. to reach the pilot's eyes.

NOTE

Revos that are equipped with an extra-large windscreen require a pilot to wear a minimum of eye protection at all times.

4.8 Normal Procedures Check List

The following checklists are a reference or a guide. Ultimately, it is the PIC's responsibility to develop checklists that work for their flights. Prior to flight a thorough pre-flight inspection of the aircraft should be carried out. Refer to sections 4.3 and 4.5 for details of the pre-flight inspection.

4.8.1 Before Engine Start

Before Engine Start	
1) Pre-Flight inspection complete	√
2) Controls deflections free and full on the ground	√
3) Passenger Briefing completed	√
4) Helmets secure	√
5) Seatbelts secure	√
6) Loose objects secure (trike and persons)	√
7) Instruments to monitor engine ON	√
8) Brakes ON	√
9) Parachute handle safety pin released (if applicable)	√
10) Area Clear	√

4.8.2 Starting Engine

<p>WARNING Never leave your aircraft unattended while the engine is running!</p>
<p>WARNING Remember to Yell CLEAR!</p>

Starting Engine 912UL and 912ULS	
1) Brakes ON	√
2) Fuel shut off valve ON	√
3) Throttles to idle (hand and foot)	√
4) Master/Main ON	√
5) Choke ON	√
6) Ignition Key to “Both”	√
7) Yell CLEAR PROP!	√
8) Ignition key engaged to “Start” –Release when engine fires	√
9) Oil Pressure (2 bars or 30 PSI within 10 sec)	√
10) Choke OFF (after initial idle warm up)	√
11) Idle adjusted to 2000 RPM	√
12) Radio check – if applicable	√

Starting Engine 912 iS	
1) Brakes ON	√
2) Fuel shut off valve ON	√
3) Throttles to idle (hand and foot)	√
4) Key/Master ON	√
5) Panel ON	√
6) Lane A and B ON	√
7) Fuel 1 and 2 ON	√
8) Yell CLEAR PROP!	√
9) Hold down the momentary start switch and Press start button simultaneously– Release both when the engine fires	√
10) Oil Pressure (2 bars or 30 PSI within 10 sec)	√
11) Make sure all Red lights go off within 10 sec	√
12) Idle adjusted to 2000 RPM	√
13) Radio check – if applicable	√

4.8.3 Taxiing

CAUTION

912 UL and ULS can overheat in 10-12 min with no airflow over the radiator. 912 iS Sport can overheat in as little as 5 min with no airflow over the radiator.

Warming up the engine, especially the 912 iS, and then taxiing may not be the best method depending on outside air temperature, length of taxi time and anticipated hold time before departure. Awareness of water temperature is important when taxiing slowly or away from the wind or holding in place. It is recommended to shut the engine off if temperature reaches 230° F, then when ready to depart start the engine again verify water temperature is less than 240°F before taking off. If temperatures are at or near 240° it is recommended to climb out at full power, but not steeply. This should result in the water temperature normalizing rapidly.

Taxiing in normal conditions is fairly straight forward.

With the engine idling, gently release the brake pedal to disengage the brakes. Position the A-frame so that it is in the approximate position for normal trim speed. The pilot's feet actuate steering on the ground. Pushing forward on the right foot peg will actuate a left turn. While pushing forward on the left foot peg will actuate a right turn

NOTE

Control sense for turning is opposite to that of a conventional three axis aircraft.

When taxiing in strong wind conditions the following procedures apply:

- Head Wind conditions requires the nose of the wing to be lowered just below the trim position.
 - Down Wind conditions requires the nose of the wing to be raised just above the trim position.
 - Cross wind conditions requires the upwind tip to be lowered slightly* (5-10° is sufficient).
- *Special note if using the Rival S wing the upwind tip should be kept up 5-10°

4.8.4 Before Take Off

CAUTION

Be careful of loose objects in the engine run-up and take off area. These objects can be sucked up by the propeller and can cause damage to the aircraft. Make sure the gas cap is secure and rear seatbelts are secured in place.

Before Take Off	
1) Brakes ON	√
2) Choke OFF (on 912UL and 912ULS)	√
3) Warm up engine – adjust idle to 2500 RPM till reach 50°C or 120° F	√
4) Oil – check temperature and pressure are in range for safe operation	√
5) Mags check for 912UL and 912ULS Increase rpm to 3800. Rpm drop with one ignition must not exceed 300 rpm and difference between each mag must not be more than 115 rpm.	√
6) Lane check and fuel pump check on 912 iS Turn off one computer (Lane A or B) at a time. Turn off one fuel pump at a time.	√
7) Fuel quantity – sufficient for flight (remember last 1.1 US Gallons of fuel is unusable) NOTE Although it is possible to use nearly every last drop of fuel in either of the gas tank configurations of the Revo, in level flight, certain flight attitudes such as 30° nose down will cause fuel starvation below 1.1 gal of fuel.	√
8) Instruments - set	√
9) Seatbelts secure	√
10) Helmets secure – chin strap secure, visor down and locked	√
11) Throttle Response – 80% On for 3 seconds, hand on key to shut engine off in case of runaway engine	√
12) Controls – pitch and roll, full and free movement.	√
13) Electric trim set for takeoff (if available)	
14) Base and final – clear of traffic	√
15) Ensure H2O temp is below 240°F if applicable	

WARNING

Keep an aircraft and engine log and enter any unusual engine behavior. Do not fly unless you have corrected a given problem and recorded the correction in the log.

4.8.5 Take Off and Initial Climb

CAUTION
High angle climb outs near the ground should be avoided.

WARNING
At low takeoff weights the TOSS can result in nose high angles that can be out of prescribed limits of +30°. The pilot must be aware of this and should keep the aircraft within prescribed limits by lowering the nose or reducing engine power appropriately.

4.8.5.1 Normal Take Off and Initial Climb

Normal Take Off and Initial Climb	
1) Pitch Control – past neutral towards the compression strut. As you speed up there may be noticeable back pressure from the control bar, keep it pushed forward.	√
2) Hand Throttle OFF	√
3) Foot Throttle – full ON	√
4) Directional Control – maintain centered	√
5) Speed – build up Take Off Safety Speed (refer to sec 4.1)	√
6) Rotate - push control bar smoothly forward so it touches the compression strut momentarily as the nose lifts and returned to trim speed before leaving ground effect.	√
7) Control bar adjusted for shallow nose angle climb close to ground.	√

WARNING
Please note of the danger of transition at initial climb from ground effect to higher altitude. It is possible to takeoff at much slower speeds and fly in ground effect but the aircraft should have accelerated in ground effect to gain enough airspeed otherwise upon transitioning from ground effect to a higher altitude, a stall may occur. In ground effect the stall speed of the aircraft is lower.

4.8.6 Climb

Climb	
1) Throttle - ON	√
2) RPM – Reduce a bit if necessary to maintain climb angle within limits (+30°) otherwise full throttle is recommended.	√
3) Airspeed –Establish Best Climb Speed (V _Y) Set electric trim to maintain airspeed (if available)	√

4.8.7 Cruise

Cruise	
1) Cruise Throttle – adjust foot throttle for level flight at desired speed and then adjust cruise hand throttle on right hand side of the trike to release pressure.	√
2) Airspeed – Establish cruise speed (Vc) Set electric trim to maintain airspeed (if available)	√

NOTE

When the hand throttle is actuated, a higher power setting can still be achieved with the use of the foot throttle. The rpm will always return to the set cruise RPM when foot throttle is disengaged. Please not to turn off the hand throttle to reduce power.

4.8.8 Descent

NOTE

You can increase these speeds for gusty conditions.

NOTE

All airspeeds are Indicated Airspeed (IAS) unless otherwise noted.

Descent	
1) Foot Throttle - reduce	√
2) Hand Throttle - OFF	√
3) Airspeed – all airspeeds are IAS <ul style="list-style-type: none"> • Competition = 75 MPH (65 Kts) (120 Km/hr) • Reflex Sport (discontinued) = 72 MPH (62.6 Kts) (115 Km/hr) • Discovery = 68 MPH (59 Kts) (109 Km/hr) • Rival (discontinued) = 72 MPH (62.6 Kts) (115 Km/hr) • Rival S = 72 MPH (62.6 Kts) (115 Km/hr) • Rival X = 68 MPH (59 Kts) (109 Km/hr) 	√
4) Set electric trim to maintain airspeed (if available)	

4.8.9 Landing

Landing	
1) Hand Throttle - OFF	√
2) Airspeed – Best Glide Speed (consult section 5.5 under your wing model name) + 0.5 Max wind gust + 3 MPH NOTE Additional speed is recommended and can be bled off in ground effect float.	√
3) Set electric trim for landing (if available)	√
4) Nose Wheel – Straight	
5) Brake Pedal - Disengage	√
6) Final - Clear	√
7) Landing – Execute properly per training	√
8) Braking – Brake OFF and then as required. Only use brake when bar has been pulled back at least mid-way.	√

Landing should always be into the wind if possible with a long straight approach in normal operations.

The landing distance specified in performance section is the measured ground distance covered from an approach at 50 ft (15 m) above the average elevation of the runway used until the aircraft makes a complete stop.

An approach to the runway can be with or without power. However, the airspeed should be maintained above the nominated approach speed in either case.

The aircraft should be flown on final approach at or above the nominated safety speed. The additional airspeed allows for wind gradient, and to provide greater controllability in the rough air that may be encountered close to the ground. Maintaining airspeed on final is very important for engine-off landings, allowing a margin for round out before touchdown. The trike is designed to land with the rear wheels touching down slightly before the nose wheel. Once all three wheels are solidly on the ground, aerodynamic braking may be achieved by pulling in the control bar, then applying the front nose wheel brake.

NOTE

In the case of a hard landing the maintenance manuals for both the wing and the carriage should be referenced. It must be noted that after a hard landing, your aircraft must be completely checked and an entry to this effect logged in the aircraft logbook.

4.8.10 Crosswind Operation

Pilots with low hours should avoid landing or taking off with high crosswind components. Pilot skills and aircraft capabilities are two separate things and lack of either one can set events in motion that can lead to accidents. Crosswind landings or take off with low wind components up to 7 knots are quite safe and controllable, even in the hands of qualified but relatively inexperienced weight shift control pilot.

The nominated approach speed should be on the higher side of the range listed when landing in cross wind conditions of 8 kts or more.

4.8.10.1 Crosswind Take Off and Initial Climb

Crosswind Take Off and Initial Climb	
1) Set electric trim to normal takeoff position (if available)	√
2) Pitch control neutral	√
3) Hand Throttle OFF	√
4) Foot Throttle – full ON	√
5) Directional Control – maintain centered	√
6) Speed – build up Take Off Safety Speed -TOSS (refer to sec 4.1) <ul style="list-style-type: none"> • TOSS – Competition = 65 MPH (56 Kts) (103 Km/hr) • TOSS – Discovery = 60 MPH (52 Kts) (96 Km/hr) • TOSS – Reflex Sport (discontinued) = 60 MPH (52 Kts) (96 Km/hr) • TOSS – Rival (discontinued) = 60 MPH (52 Kts) (96 Km/hr) • TOSS – Rival S = 60 MPH (52 Kts) (96 Km/hr) • TOSS – Rival X = 60 MPH (52 Kts) (96 Km/hr) 	√
NOTE All airspeeds are Indicated Airspeed (IAS)	
7) Rotate - push control bar forward so it touches the compression strut.	√
8) Control bar pressure released smoothly and speed adjusted for shallow nose angle climb close to ground. Trike will lift off quickly and establish a crab angle into the wind to maintain ground track.	√

4.8.10.2 Crosswind Landing

Crosswind Landing	
1) Hand Throttle - OFF	√
2) Airspeed – Best Glide Speed (consult section 5.5 under your wing model name) + 0.5 Max wind gust + 3 MPH NOTE Additional speed is recommended and can be bled off in ground effect float.	√
3) Set electric trim for landing (if available)	√
4) Nose Wheel – Straight	
5) Brake Pedal - Disengage	√
6) Final - Clear	√
7) Landing – Execute properly per training	√
8) Braking – Brake OFF and then as required. Only use brake when bar has been pulled back at least mid-way.	√
9) Touch down crabbed. Avoid pulling the bar in until after the nose wheel has made contact with the runway.	√

WARNING

In crosswind landings, after planting the mains on the ground, it is very important especially on paved runways as opposed to grass fields, higher crosswind component that the nose wheel be kept flying and kept above the ground until the trike carriage has time to line up straight with the direction of travel before nose wheel comes in contact with the ground. Not doing so can flip your trike on its side and cause injuries.

On grass runways, the wheel can possibly slide sideways on the grass but that will not be the case on paved runways. Proper technique and instruction is required for crosswind landings in the higher range crosswind component.

After a full touchdown in crosswind conditions, the relative airflow over the wing will become increasingly higher from tip to tip as the aircraft slows down. The upwind wing tip should be lowered slightly. This amount depends on the wind strength, and the carriage wheels should retain firm contact with the ground.

Take off procedure is unchanged for the nominated crosswind component. The upward wing may need to be lowered at the start of the takeoff procedures in higher crosswinds but make sure the wings are level at the point of lift off or a turn immediately following the liftoff will result.

WARNING

The upwind wing may need to be lowered at the start of the takeoff procedure in higher crosswinds but make sure the wings are level at the point of lift off or a turn immediately after liftoff will result.

4.8.11 After Landing

After Landing	
1) Controls – secure (wing tied properly to the compression strut, upwind wing tip down)	√
2) Electrical Switches – OFF (landing light, strobe, leave Master on)	√
3) Ignition - OFF	√
4) Master - OFF	√
5) Seatbelts – unlatched, set gently aside	√
6) Parachute Pin - inserted	√
7) Set parking brake	√
8) Exit – exit the aircraft and help passenger exit if necessary	√

4.8.12 Parking the Aircraft

Park the aircraft in a crosswind position with the wings control bar secured to the compression strut with the bungee supplied. The wingtip facing the wind should lowered.

4.8.13 Go Around

During a situation where a go around is required, normal take off power and procedures should be used and enough airspeed should be built up before raising the nose of the trike for climb out.

4.8.14 Ideal Minimum Safe Runway Length

It is common for pilots to try to calculate the shortest possible runway to use. Evolution Aircraft Inc. strongly recommends using a runway that is long enough so that a straight ahead landing can be made on the runway in the event of an engine failure on takeoff up until safe altitude is reached whereby a 180° turn can be made to land downwind on the same runway. Pilots often have a false sense of security when overhead a runway, when in reality they are in the danger zone and outside the cone of flight safety. Often the runway is too short to land straight ahead on and too short to allow sufficient altitude for a 180° turn back to the runway, thus an engine failure over the runway could lead to an off-field accident. The approximate lowest altitude, dependent on pilot skill and environmental factors, etc., for a 180° turn to landing is 300-500 ft AGL.

NOTE

Calculate the ideal minimum safe runway length like this:

Takeoff distance to 15 m (50 ft) + distance to climb to 300+ feet at best climb + distance to descend from 300 feet to 50 ft + landing distance from 15 m (50 feet).

This assumes perfect pilot skill, and thus should be multiplied by a safety factor.

CAUTION

Pilots may be surprised to discover that this ideal safe runway can be over 2500 ft. (762 meters) long, and discover that the runway they operate from has an unsafe zone right overhead the runway towards the center.

Runways surrounded by safe landing areas or with good overshoots, however, do not need this ideal length.

4.9 Separating Wing from Trike Carriage

Separating Wing from Trike Carriage
1) Make sure the conditions are not extremely windy in the area that this is being done.
2) Make sure that the ignition is off and BRS pin secured and inserted if applicable.
3) Optionally if fitted with wing training bars, it will be advantageous to remove the training bars from the wing at this point but that is not necessary.
4) Remove the wind shield using quick release snap fittings securing the windshield.
5) Position trike carriage so it is pointing into the wind.
6) Wrap the rear seat belt around the pilot seat back to act as a mast stop.
7) Bring the wing control bar in front of the compression strut by utilizing the front strut hinge and releasing the front strut at the bracket on the trike body. Once this control bar is in front of the compression strut instead of behind, the secure the front strut again at the bottom with the pin into the bracket at the trike body and one pin temporarily inserted as a stop to secure the slider against.
8) Removal of the back seat backrest will allow access to mast bracket bolt. Remove the arm rests is equipped. Release the mast bolt located on the mast behind the back seat.
9) Lift the control bar overhead and with one hand slide up the compression strut slider so that the compression strut can fold forward.
10) Lower the control bar down over and in front of the trike fairing. The wing keel will rest against mast and provide leverage.
11) Once the control bar is on the ground, pull the nose forward until the nose wheel runs over the control bar. This will relieve the torque on the hang bolt.
12) Disconnect the safety backup cable, antenna and electric plug for trim motor Also, disconnect the hang block from the mast by removing the hang bolt.
13) Remove the nose cone from the wing and lower the wing to its nose, while resting the mast on the pilot seat back.
14) Gently slide the trike carriage backwards away from the wing by pushing it backwards making sure that the trike pod/fairing clears the A-frame down tubes. Hold the wing while doing this with one hand.

4.10 Wing Breakdown Procedure

Please refer to the wing manual. If equipped with a linear actuator for electric trim, please remember to take the linear actuator out of the wing before folding.

4.11 Transportation and Storage

4.11.1 Transporting by Trailer

During transport, secure the trike carriage at both the front and the rear to prevent movement. Tie down straps should be used with a ratchet system so preload can be applied; this allows the tires to be compressed slightly to firmly hold the base in place during transport.

The best place to tie down the REVO carriage is by placing the strap of a ratchet tie down through the axle carriers. Two straps per side. One goes forward and one back. The completed rigging forms an X under the belly of the REVO when secured. The nose wheel does need to be secured down as well. The 4 straps at the rear will hold the rear down and prevent the entire trike from moving in any horizontal direction. The soft part of the ratchet strap can be looped over the front axle to accomplish this.

When transporting the trike carriage on an open trailer, the use of trike and prop covers to protect the aircraft from road grime is recommended. Tie the propeller to the trike to stop it from rotating at speed.

Transporting the wing packed in its bag, off the trike for long distances, is recommended. The bag is **NOT** waterproof; however, an optional waterproof bag that goes over the existing wing bag is available as an option. During transportation, or when stored on slings, the wing must be supported at a minimum of three places including:

- a) Its center
- b) Two points less than 3 ft (1 m) from each end.

The padding supplied with the wing must be used to prevent chaffing during transport. Supports should be softly padded, and any support systems used for transport, such as roof racks, must use attachment straps that are sufficiently secure to eliminate the possibility of damage from vibration and movement.

Avoid damage to your wing by using well-padded racks. As the wing is quite heavy a strong set of racks are required.

Check that the back of the wing is well clear of the front mast with the trike on the trailer. Remember there is an overhanging load when maneuvering in tight places.

Store the wing in a dry room off the ground; air the wing out regularly to avoid mildew, and never store wet.

A proper trailer, like the one supplied by Evolution Aircraft Inc., can be used in conjunction with topless models of wings on smooth roads to be able to trailer the wing and carriage being still attached.

For short distances, like transport to a local airfield on smooth roads, attach the wing to the trike carriage and transport it standing upright on its control. Place the control bar in a padded chalice on the trailer. The wing bag can partially go on the wing at the nose. Its best to leave the two tips of the wing apart and not completely closed. Straps should secure the sail on each side so the sail remains packed to the leading edge tubes. The wing leading edges should rest secured against some padded material. The trike carriage in this case should be secured as normal on to the trailer besides the wing.

4.11.2 Packed in a Crate

Empty the fuel tank and the carburetor bowls on the 912UL and 912ULS. Remove the propeller and pack it with the blade covers and bubble wrap or soft packing material and put in a box. Disconnect the battery ground. Remove the rear landing gear and support the engine from moving laterally by securing the prop drive.

4.11.3 Parachute

Aircraft equipped with parachutes deployed by pyrotechnic rockets are covered by particular Regulations according to the Country of Registration of the Aircraft, you must know and adhere to these Regulations. Evolution Aircraft, Inc. cannot ship a trike equipped with a Ballistic Rocket for the parachute as it's against the law to ship such material without licenses held by the parachute Manufacturer. In the USA, if a BRS parachute is taken as an option, the trike has to be delivered locally or the rocket must be drop shipped directly from BRS.

4.11.4 Storage

Thoroughly check and clean the trike carriage prior to storage. After cleaning, wipe all metal components with a clean lightly oiled cloth, while avoiding joints and rubberized parts. If the trike carriage is to be stored for a long period (e.g. 2 or more months):

- Place a well-oiled cloth in the open end of the exhaust.
- Cover the air filter with several layers of protection to prevent condensation.
- Drain the fuel tank. Drain fuel system by shutting off fuel valve and then running the engine.
- Empty carb bowls on the 912UL and 912ULS. Recent fuel additives will tend to gum up in the system. For further information on long-term storage of the engine, please refer to the engine manuals.
- Disconnect the battery terminals and tape them off with electrical tape.

A trike cover is recommended to secure against rodents and cobwebs while in storage.

See your engine manual for precautions to be observed if you intend to store the aircraft without use for extended periods.

5 Performance

5.1 General

The performance data in this section has been gathered from flight testing the aircraft with power plant and wing in good condition and using average piloting techniques. It should be noted that climatic conditions, piloting techniques and aircraft condition will cause significant variation to this data.

5.2 Take Off and Landing

5.2.1 Take Off

5.2.1.1 ISA Conditions, Clean Dry Runway, Calm Winds, Standard Day (sea level 59°F)

Performance at MTOW with 912UL (80 HP)	Metric	Imperial
Discovery - Take off distance to 50 ft (15 m)	289 m	950 ft
Reflex Sport (discontinued) - Take off distance to 50 ft (15 m)	305 m	1000 ft
Competition - Take off distance to 50 ft (15 m)	n/a	n/a
Rival (discontinued) - Take off distance to 50 ft (15 m)	n/a	n/a
Rival S - Take off distance to 50 ft (15 m)	n/a	n/a
Rival X - Take off distance to 50 ft (15 m)	n/a	n/a

Performance at MTOW with 912ULS (100 HP)	Metric	Imperial
Discovery - Take off distance to 50 ft (15 m)	260 m	855 ft
Reflex Sport (discontinued) - Take off distance to 50 ft (15 m)	275 m	902 ft
Competition - Take off distance to 50 ft (15 m)	290 m	951 ft
Rival (discontinued) - Take off distance to 50 ft (15 m)	282 m	920 ft
Rival S - Take off distance to 50 ft (15 m)	282 m	920 ft
Rival X - Take off distance to 50 ft (15 m)	259 m	850 ft

5.2.1.2 3000 ft (914 m) Density Altitude, Clean Dry Runway, Calm Winds

Performance at typical weight of 820 lbs (373 kg) with 912UL (80 HP)	Metric	Imperial
Discovery - Take off distance to 50 ft (15 m)	320 m	1050 ft
Reflex Sport (discontinued) - Take off distance to 50 ft (15 m)	328 m	1075 ft
Competition - Take off distance to 50 ft (15 m)	n/a	n/a
Rival (discontinued) - Take off distance to 50 ft (15 m)	n/a	n/a
Rival S - Take off distance to 50 ft (15 m)	n/a	n/a
Rival X - Take off distance to 50 ft (15 m)	n/a	n/a

Performance at typical weight of 820 lbs (373 kg) with 912ULS (100 HP)	Metric	Imperial
Discovery - Take off distance to 50 ft (15 m)	282 m	925 ft
Reflex Sport (discontinued) - Take off distance to 50 ft (15 m)	293 m	960 ft
Competition - Take off distance to 50 ft (15 m)	311 m	1020 ft
Rival (discontinued) - Take off distance to 50 ft (15 m)	298 m	980 ft
RIVAL S - Take off distance to 50 ft (15 m)	298 m	980 ft
RIVAL X - Take off distance to 50 ft (15 m)	281 m	920 ft

The following factors will increase takeoff distance:

- a) Tail wind
- b) Tall grass on runway
- c) Higher density altitude
- d) Pilot skill

PIC is required to take into account the effects of these adverse factors while planning a takeoff.

5.2.2 Landing

5.2.2.1 ISA Conditions, Clean Dry Runway, Calm Winds

Performance at MTOW	Metric	Imperial
Rival X - Landing distance from 50 ft (15 m)	274 m	900 ft
Rival S - Landing distance from 50 ft (15 m)	274 m	900 ft
Rival (discontinued) - Landing distance from 50 ft (15 m)	274 m	900 ft
Discovery - Landing distance from 50 ft (15 m)	274 m	900 ft
Reflex Sport (discontinued) - Landing distance from 50 ft (15 m)	274 m	900 ft
Competition - Landing distance from 50 ft (15 m)	274 m	900 ft

Performance at typical weight of 820 lbs (373 kg)	Metric	Imperial
Rival X - Landing distance from 50 ft (15 m)	244 m	800 ft
Rival S - Landing distance from 50 ft (15 m)	244 m	800 ft
Rival (discontinued) - Landing distance from 50 ft (15 m)	244 m	800 ft
Discovery - Landing distance from 50 ft (15 m)	244 m	800 ft
Reflex Sport (discontinued) - Landing distance from 50 ft (15 m)	244 m	800 ft
Competition - Landing distance from 50 ft (15 m)	244 m	800 ft

5.2.2.2 3000 ft (914 m) Density Altitude, Clean Dry Runway, Calm Winds

Performance at MTOW	Metric	Imperial
Discovery - Landing distance from 50 ft (15 m)	305 m	1000 ft
Reflex Sport (discontinued) - Landing distance from 50 ft (15 m)	305 m	1000 ft
Competition - Landing distance from 50 ft (15 m)	305 m	1000 ft
Rival - Landing distance from 50 ft (15 m)	305 m	1000 ft
Rival S - Landing distance from 50 ft (15 m)	305 m	1000 ft
Rival X - Landing distance from 50 ft (15 m)	305 m	1000 ft

Performance at typical weight of 820 lbs (373 kg)	Metric	Imperial
Discovery - Landing distance from 50 ft (15 m)	277 m	910 ft
Reflex Sport (discontinued) - Landing distance from 50 ft (15 m)	277 m	910 ft
Competition - Landing distance from 50 ft (15 m)	277 m	910 ft
Rival (discontinued) - Landing distance from 50 ft (15 m)	277 m	910 ft
Rival S - Landing distance from 50 ft (15 m)	277 m	910 ft
Rival X - Landing distance from 50 ft (15 m)	277 m	910 ft

The following factors will increase landing distance:

- a) Brakes not working optimally
- b) Tail wind
- c) Downhill landing
- d) Density altitude
- e) Pilot skill

PIC is required to take into account the effects of these adverse factors while landing.

Direct crosswind components of up to 14 knots at gross weight are within Revo’s operating limitations.

Always plan conservatively when selecting locations for takeoff and landing. Leave some margin for appropriate procedure to be performed in the event of sudden engine failure or turbulence.

5.3 Climb

5.3.1 ISA Conditions, Calm Winds, Sea Level, MTOW

NOTE

All airspeeds are Indicated Airspeed (IAS)

Performance at MTOW with 912ULS, 100 HP	Metric	Imperial
Discovery (MTOW = 1060 lbs, 482 kg)		
Climb Rate	5.4 m/sec	1060 FPM
Best Climb Speed	101 km/hr	63 MPH (55 Kts)
Reflex Sport (MTOW = 1040 lbs, 472.5 kg) (discontinued)		
Climb Rate	5.3 m/sec	1040 FPM
Best Climb Speed	104 km/hr	65 MPH (56 Kts)
Competition (MTOW = 1040 lbs, 472.5 kg)		
Climb Rate	5 m/sec	1000 FPM
Best Climb Speed	104 km/hr	65 MPH (56 Kts)
Rival (MTOW = 1060 lbs, 482 kg) (discontinued)		
Climb Rate	5 m/sec	1000 FPM
Best Climb Speed	104 km/hr	65 MPH (56 Kts)
Rival S (MTOW = 1160 lbs, 526 kg)		
Climb Rate	5 m/sec	1000 FPM
Best Climb Speed	104 km/hr	65 MPH (56 Kts)
Rival X (MTOW = 1160 lbs, 526 kg)		
Climb Rate	5.4 m/sec	1060 FPM
Best Climb Speed	101 km/hr	63 MPH (55 Kts)
Performance at MTOW with 912UL 80 HP		
Discovery (MTOW = 1060 lbs, 482 kg)		
Climb Rate	4.5 m/sec	885 FPM
Best Climb Speed	101 km/hr	63 MPH (55 Kts)
Reflex Sport (MTOW = 1040 lbs, 472.5 kg) (discontinued)		
Climb Rate	4.3 m/sec	860 FPM
Best Climb Speed	104 km/hr	65 MPH (56 Kts)
Competition (MTOW = 1040 lbs, 472.5 kg)		

Climb Rate	N/A	N/A
Best Climb Speed	N/A	N/A
Rival/ RIVAL S/X (MTOW = 1160 lbs, 526 kg)		
Climb Rate	N/A	N/A
Best Climb Speed	N/A	N/A

NOTE

All airspeeds are Indicated Airspeed (IAS)

Performance at MTOW with 912iS, 100 HP	Metric	Imperial
Discovery (MTOW = 1060 lbs, 482 kg)		
Climb Rate	5.4 m/sec	1060 FPM
Best Climb Speed	101 km/hr	63 MPH (55 Kts)
Reflex Sport (MTOW = 1040 lbs, 472.5 kg) (discontinued)		
Climb Rate	5.3 m/sec	1040 FPM
Best Climb Speed	104 km/hr	65 MPH (56 Kts)
Competition (MTOW = 1040 lbs, 472.5 kg)		
Climb Rate	5 m/sec	1000 FPM
Best Climb Speed	104 km/hr	65 MPH (56 Kts)
Rival (MTOW = 1060 lbs, 482 kg) (discontinued)		
Climb Rate	5 m/sec	1000 FPM
Best Climb Speed	104 km/hr	65 MPH (56 Kts)
Rival S (MTOW = 1160 lbs, 526 kg)		
Climb Rate	5 m/sec	1000 FPM
Best Climb Speed	104 km/hr	65 MPH (56 Kts)
Rival X (MTOW = 1160 lbs, 526 kg)		
Climb Rate	5.4 m/sec	1060 FPM
Best Climb Speed	101 km/hr	63 MPH (55 Kts)

5.3.2 ISA Conditions, Calm Winds, Sea Level, 820 lbs (373kg)

NOTE

All airspeeds are Indicated Airspeed (IAS)

Performance at MTOW with 912ULS, 100 HP	Metric	Imperial
Discovery (MTOW = 1060 lbs, 482 kg)		
Climb Rate	6 m/sec	1180FPM
Best Climb Speed	101 km/hr	63 MPH (55 Kts)
Reflex Sport (MTOW = 1040 lbs, 472.5 kg) (discontinued)		
Climb Rate	6 m/sec	1180 FPM
Best Climb Speed	104 km/hr	65 MPH (56 Kts)
Competition (MTOW = 1040 lbs, 472.5 kg)		
Climb Rate	5.9 m/sec	1160 FPM
Best Climb Speed	104 km/hr	65 MPH (56 Kts)

Rival (MTOW = 1060 lbs, 482 kg) (discontinued)		
Climb Rate	5.9 m/sec	1160 FPM
Best Climb Speed	104 km/hr	65 MPH (56 Kts)
Rival S (MTOW = 1160 lbs, 526 kg)		
Climb Rate	5.9 m/sec	1160 FPM
Best Climb Speed	104 km/hr	65 MPH (56 Kts)
Rival X (MTOW = 1160 lbs, 526 kg)		
Climb Rate	6 m/sec	1180FPM
Best Climb Speed	101 km/hr	63 MPH (55 Kts)

NOTE

All airspeeds are Indicated Airspeed (IAS)

Performance at MTOW with 912UL 80 HP		
Discovery (MTOW = 1060 lbs, 482 kg)		
Climb Rate	5 m/sec	1000 FPM
Best Climb Speed	101 km/hr	63 MPH (55 Kts)
Reflex Sport (MTOW = 1040 lbs, 472.5 kg) (discontinued)		
Climb Rate	4.98m/sec	980 FPM
Best Climb Speed	104 km/hr	65 MPH (56 Kts)
Competition/ Rival/ Rival S/X		
Climb Rate	N/A	N/A
Best Climb Speed	N/A	N/A
Performance at MTOW with 912iS 100 HP		
Discovery (MTOW = 1060 lbs, 482 kg)		
Climb Rate	6 m/sec	1180 FPM
Best Climb Speed	101 km/hr	63 MPH (55 Kts)
Reflex Sport (MTOW = 1040 lbs, 472.5 kg) (discontinued)		
Climb Rate	6 m/sec	1180 FPM
Best Climb Speed	104 km/hr	65 MPH (56 Kts)
Competition (MTOW = 1040 lbs, 472.5 kg)		
Climb Rate	5.9 m/sec	1060 FPM
Best Climb Speed	104 km/hr	65 MPH (56 Kts)
Rival (MTOW = 1060 lbs, 482 kg) (discontinued)		
Climb Rate	5.9 m/sec	1060 FPM
Best Climb Speed	104 km/hr	65 MPH (56 Kts)
Rival S (MTOW = 1160 lbs, 526 kg)		
Climb Rate	5.9 m/sec	1060 FPM
Best Climb Speed	104 km/hr	65 MPH (56 Kts)
RIVAL X (MTOW = 1160 lbs, 526 kg)		
Climb Rate	6 m/sec	1180 FPM
Best Climb Speed	101 km/hr	63 MPH (55 Kts)

5.3.3 3000 ft (914m) Density Altitude, Calm Winds, MTOW

NOTE

All airspeeds are Indicated Airspeed (IAS)

Performance at MTOW with 912ULS, 100 HP	Metric	Imperial
Discovery (MTOW = 1060 lbs, 482 kg)		
Climb Rate	4.5 m/sec	885FPM
Best Climb Speed	101 km/hr	63 MPH (55 Kts)
Reflex Sport (MTOW = 1040 lbs, 472.5 kg) (discontinued)		
Climb Rate	4.3 m/sec	850 FPM
Best Climb Speed	104 km/hr	65 MPH (56 Kts)
Competition (MTOW = 1040 lbs, 472.5 kg)		
Climb Rate	3.9m/sec	770 FPM
Best Climb Speed	104 km/hr	65 MPH (56 Kts)
Rival (MTOW = 1060 lbs, 482 kg) (discontinued)		
Climb Rate	4.1 m/sec	807 FPM
Best Climb Speed	104 km/hr	65 MPH (56 Kts)
Rival S (MTOW = 1160 lbs, 526 kg)		
Climb Rate	4.1 m/sec	807 FPM
Best Climb Speed	104 km/hr	65 MPH (56 Kts)
Rival X (MTOW = 1160 lbs, 526 kg)		
Climb Rate	4.5 m/sec	885FPM
Best Climb Speed	101 km/hr	63 MPH (55 Kts)
Performance at MTOW with 912UL 80 HP		
Discovery (MTOW = 1060 lbs, 482 kg)		
Climb Rate	3.9 m/sec	770 FPM
Best Climb Speed	101 km/hr	63 MPH (55 Kts)
Reflex Sport (MTOW = 1040 lbs, 472.5 kg) (discontinued)		
Climb Rate	3.8 m/sec	750 FPM
Best Climb Speed	104 km/hr	65 MPH (56 Kts)
Competition (MTOW = 1040 lbs, 472.5 kg)		
Climb Rate	N/A	N/A
Best Climb Speed	N/A	N/A
Rival (MTOW = 1060 lbs, 482 kg) (discontinued)		
Climb Rate	N/A	N/A
Best Climb Speed	N/A	N/A
Rival S/X (MTOW = 1160 lbs, 526 kg)		
Climb Rate	N/A	N/A
Best Climb Speed	N/A	N/A

Performance at MTOW with 912iS 100 HP		
Discovery (MTOW = 1060 lbs, 482 kg)		
Climb Rate	4.5 m/sec	885 FPM
Best Climb Speed	101 km/hr	63 MPH (55 Kts)
Reflex Sport (MTOW = 1040 lbs, 472.5 kg) (discontinued)		
Climb Rate	4.3 m/sec	850 FPM
Best Climb Speed	104 km/hr	65 MPH (56 Kts)
Competition (MTOW = 1040 lbs, 472.5 kg)		
Climb Rate	3.9 m/sec	770 FPM
Best Climb Speed	104 km/hr	65 MPH (56 Kts)
Rival (MTOW = 1060 lbs, 482 kg) (discontinued)		
Climb Rate	4.1 m/sec	807 FPM
Best Climb Speed	104 km/hr	65 MPH (56 Kts)
Rival S (MTOW = 1160 lbs, 526 kg)		
Climb Rate	4.1 m/sec	807 FPM
Best Climb Speed	104 km/hr	65 MPH (56 Kts)
Rival X (MTOW = 1160 lbs, 526 kg)		
Climb Rate	4.5 m/sec	885FPM
Best Climb Speed	101 km/hr	63 MPH (55 Kts)

5.3.4 3000 ft (914m) Density Altitude, Calm Winds, 820 lbs (373kg)

NOTE

All airspeeds are Indicated Airspeed (IAS)

Performance at MTOW with 912ULS, 100 HP	Metric	Imperial
Discovery (MTOW = 1060 lbs, 482 kg)		
Climb Rate	5 m/sec	1000 FPM
Best Climb Speed	101 km/hr	63 MPH (55 Kts)
Reflex Sport (MTOW = 1040 lbs, 472.5 kg) (discontinued)		
Climb Rate	5 m/sec	1000 FPM
Best Climb Speed	104 km/hr	65 MPH (56 Kts)
Competition (MTOW = 1040 lbs, 472.5 kg)		
Climb Rate	4.5 m/sec	880 FPM
Best Climb Speed	104 km/hr	65 MPH (56 Kts)
Rival (MTOW = 1060 lbs, 482 kg) (discontinued)		
Climb Rate	4.8 m/sec	945 FPM
Best Climb Speed	104 km/hr	65 MPH (56 Kts)
Rival S (MTOW = 1160 lbs, 526 kg)		
Climb Rate	4.8 m/sec	945 FPM
Best Climb Speed	104 km/hr	65 MPH (56 Kts)
Rival X (MTOW = 1160 lbs, 526 kg)		
Climb Rate	4.5 m/sec	885FPM
Best Climb Speed	101 km/hr	63 MPH (55 Kts)

Performance at MTOW with 912UL 80 HP		
Discovery (MTOW = 1060 lbs, 482 kg)		
Climb Rate	4 m/sec	790 FPM
Best Climb Speed	101 km/hr	63 MPH (55 Kts)
Reflex Sport (MTOW = 1040 lbs, 472.5 kg) (discontinued)		
Climb Rate	3.9 m/sec	770 FPM
Best Climb Speed	104 km/hr	65 MPH (56 Kts)
Competition (MTOW = 1040 lbs, 472.5 kg)		
Climb Rate	N/A	N/A
Best Climb Speed	N/A	N/A
Rival (MTOW = 1060 lbs, 482 kg) (discontinued)		
Climb Rate	N/A	N/A
Best Climb Speed	N/A	N/A
Rival S/X (MTOW = 1160 lbs, 526 kg)		
Climb Rate	N/A	N/A
Best Climb Speed	N/A	N/A
Performance at MTOW with 912iS 100 HP		
Discovery (MTOW = 1060 lbs, 482 kg)		
Climb Rate	5 m/sec	1000 FPM
Best Climb Speed	101 km/hr	63 MPH (55 Kts)
Reflex Sport (MTOW = 1040 lbs, 472.5 kg) (discontinued)		
Climb Rate	5 m/sec	1000 FPM
Best Climb Speed	104 km/hr	65 MPH (56 Kts)
Competition (MTOW = 1040 lbs, 472.5 kg)		
Climb Rate	4.5 m/sec	880 FPM
Best Climb Speed	104 km/hr	65 MPH (56 Kts)
Rival (MTOW = 1060 lbs, 482 kg) (discontinued)		
Climb Rate	4.8 m/sec	945 FPM
Best Climb Speed	104 km/hr	65 MPH (56 Kts)
Rival S (MTOW = 1160 lbs, 526 kg)		
Climb Rate	4.8 m/sec	945 FPM
Best Climb Speed	104 km/hr	65 MPH (56 Kts)
Rival X (MTOW = 1160 lbs, 526 kg)		
Climb Rate	5 m/sec	1000 FPM
Best Climb Speed	101 km/hr	63 MPH (55 Kts)

5.4 Stall Speeds

Wing Model	Metric	Imperial
Discovery	61 km/hr	38 MPH (33 Kts)
Reflex Sport (discontinued)	63 km/hr	39 MPH (34 Kts)
Competition	69 km/hr	40 MPH (35 Kts)
Rival (discontinued)	66 km/hr	40 MPH (35 Kts)
Rival S	69 km/hr	40 MPH (35 Kts)
Rival X	69 km/hr	37 MPH (32 Kts)

5.5 Glide

Glide data has been obtained with the engine off at MTOW at best glide speed for each wing at ISA conditions, calm winds. The best speed to use in an emergency to achieve most travel will vary with conditions. Generally, if you wanted to cover more distance in a headwind by gliding, you will have to compensate the best glide speed for calm conditions by increasing the speed a bit. If you had a tailwind and wanted to cover more distance by gliding then the speed to establish would be slower than best glide speed and possibly minimum sink speed.

WARNING

Pilot training, experience, familiarity with your aircraft is your responsibility. We suggest experimenting with these scenarios when your engine is running by going to idle so you have a better idea of how your aircraft will behave in glide in different wind conditions.

NOTE

All airspeeds are Indicated Airspeed (IAS)

Performance for Best Glide (L/D max) Speed	Metric	Imperial
Discovery (10.5:1)	96 km/hr	60 MPH (52 Kts)
Reflex Sport (10.5 :1) (discontinued)	100 Km/hr	62 MPH (54 Kts)
Competition (9.0:1)	106 km/hr	66 MPH (57 Kts)
Rival (9.2:1) (discontinued)	100 km/hr	62 MPH (57 Kts)
Rival S (9.2:1)	100 km/hr	62 MPH (57 Kts)
Rival X (9.5:1)	90 km/hr	56 MPH (49 Kts)

5.5.1 Max Glide Speeds to Fly (Rules Of Thumb)

- Speed to fly for max glide in a tailwind = min sink speed
- Speed to fly for max glide in a headwind = best L/D speed + 1/2 wind speed

5.6 Cruise

Cruise performance on the Revo is listed for mid-trim setting with the bar pulled in pressure that can be easily held for long periods for time without much effort on the part of the pilot. Trim speed settings are also listed. The data is listed in IAS at close to full weight and is for Rotax 912 UL, ULS and iS series engines in calm wind conditions.

NOTE

All airspeeds are Indicated Airspeed (IAS)

Performance at Slowest Trim Setting (hands off cruise)	Metric	USA	Fuel Burn Metric	Fuel Burn USA
Discovery 912 UL/ULS 912 iS	88 km/hr	55 MPH (48 Kts)	7.2 liters/hr 5.4 liters/hr	1.90 GPH 1.30 GPH
Reflex Sport 912 UL/ULS (discontinued) 912 iS	88 km/hr	55 MPH (48 Kts)	7.2 liters/hr 5.4 liters/hr	1.90 GPH 1.30 GPH

Competition	912UL/ULS 912 iS	96 km/hr	60 MPH (52 Kts)	9.0 liters/hr 6.3 liters/hr	2.40 GPH 1.68 GPH
Rival (discontinued)	912 UL/ULS 912 iS	96 km/hr	60 MPH (52 Kts)	9.0 liters/hr 6.3 liters/hr	2.40 GPH 1.68 GPH
Rival S	912 UL/ULS 912iS	96 km/hr	60 MPH (52 Kts)	9.0 liters/hr 6.3 liters/hr	2.40 GPH 1.68 GPH
Rival X	912 UL/ULS 912iS	88 km/hr	55 MPH (48 Kts)	7.2 liters/hr 5.4 liters/hr	1.90 GPH 1.30 GPH
Performance at normal cruise					
Discovery	912UL/ULS 912 iS	117 km/hr	73 MPH (59 Kts)	14 liters/hr 9.8 liters/hr	3.70 GPH 2.59 GPH
Reflex Sport (discontinued)	912UL/ULS 912 IS	122 km/hr	76 MPH (66 Kts)	14.6 liters/hr 10.22 liters/hr	3.85 GPH 2.69 GPH
Competition	912UL/ULS 912 IS	130 km/hr	81 MPH (70 Kts)	17.0 liters/hr 11.9 liters/hr	4.50 GPH 2.94 GPH
Rival (discontinued)	912UL/ULS 912 IS	130 km/hr	78MPH (67 Kts)	15.0 liters/hr 10.5 liters/hr	4.20 GPH 2.94 GPH
Rival S	912UL/ULS 912 IS	130 km/hr	78MPH (67 Kts)	15.0 liters/hr 10.5 liters/hr	4.20 GPH 2.94 GPH
Rival X 912 IS	912UL/ULS	117 km/hr	73 MPH (59 Kts)	14 liters/hr 9.8 liters/hr	3.70 GPH 2.59 GPH

NOTE

Fuel consumption data was collected in US units and are included as a guide only. Changes in aircraft configuration, load, altitude, wind gust strength as well as climatic conditions can cause significant variation in fuel consumption. Always carry a reserve of fuel beyond the planned flight of at least 30 minutes.

WARNING

Not carrying enough reserve fuel or not heeding the low fuel and other engine and flight parameter warnings flashed by the instrumentation can cause serious injury or death.

6 Weight and Loading

Center of gravity limits are not critical in a flex wing weight shift control aircraft. The carriage attaches to the wing through a universal junction known as hang block assembly. Variations in cockpit and fuel loading cannot affect aircraft's balance. The Revo is therefore not critical in terms of center of gravity. However, distribution of load in a trike carriage affects the attitude of the trike carriage in-flight in a minor way.

Please refer to weight and loading document for the particular aircraft as that document over-rides the generalized information here.

6.1 Center of Gravity Limits

Refer to the **weight and loading document** of the aircraft.

NOTE

If the wing is optionally equipped with electric in-flight trim, it is possible to change the CG in flight by using the electric trim. Do not exceed V_{NE} using electric trim in a dive attitude.

NOTE

There is a max 250 lbs (113 Kg) per seat max weight limit. Remain under gross weight of aircraft. Refer to each individual aircraft weight and loading document for more detail. Minimum weight in the front seat is 90 lbs (40 kg).

NOTE

The trike may optionally be equipped with an electric trim device that allows the pilot to change the trim position of the wing within limits to speed up or slow down the aircraft. In such a case, it is advisable that pilots set their trim position in the slow to center of the range for takeoff and slow down the aircraft to proper approach speed using this trim during an approach to landing (control bar approximately 10 in from compression strut). If the electric trim is not set properly, it may take longer to takeoff than normal and also the aircraft may have excess airspeed to bleed off before touchdown at the proper speed during landing. If the runway is long enough this is not a problem.

Center of Gravity Limits

Base hang point Range	Dimension (Metric - millimeters)	Dimension (Imperial/US - inches)
Competition (from front edge of nose keel tube of the wing to the center of the hangbolt)	1295 mm – 1397 mm	51” – 55”
Reflex Sport (discontinued) (from front edge of nose keel tube of the wing to the center of the hangbolt)	1346 mm – 1448 mm	53” - 57”
Discovery (from front edge of nose keel tube of the wing to the center of the hangbolt)	1397 mm – 1499 mm	55” – 59”
Rival (discontinued) (from front edge of nose keel tube of the wing to the center of the hangbolt)	1270 mm –1397 mm	50” – 55”
RIVAL S (from front edge of nose keel tube of the wing to the center of the hangbolt)	1267 mm –1394 mm	49” – 54”
RIVAL X (from front edge of nose keel tube of the wing to the center of the hangbolt)	1320 mm –1447 mm	52” – 57”

7 Descriptions of the Aircraft and Its Systems

7.1 General

This section gives general description of the aircraft, controls, instruments, and optional equipment. Information on the aircraft flight controls is detailed in this section, but it is mandatory that you receive professional training prior to any solo flight. Local laws govern the use of this aircraft where applicable. In the US Sport Pilot license in WSC category is required at a minimum to pilot the Revo.

7.2 Airframe

The following pictures show the various controls located in the cockpit and outside of the Revo including storage area.

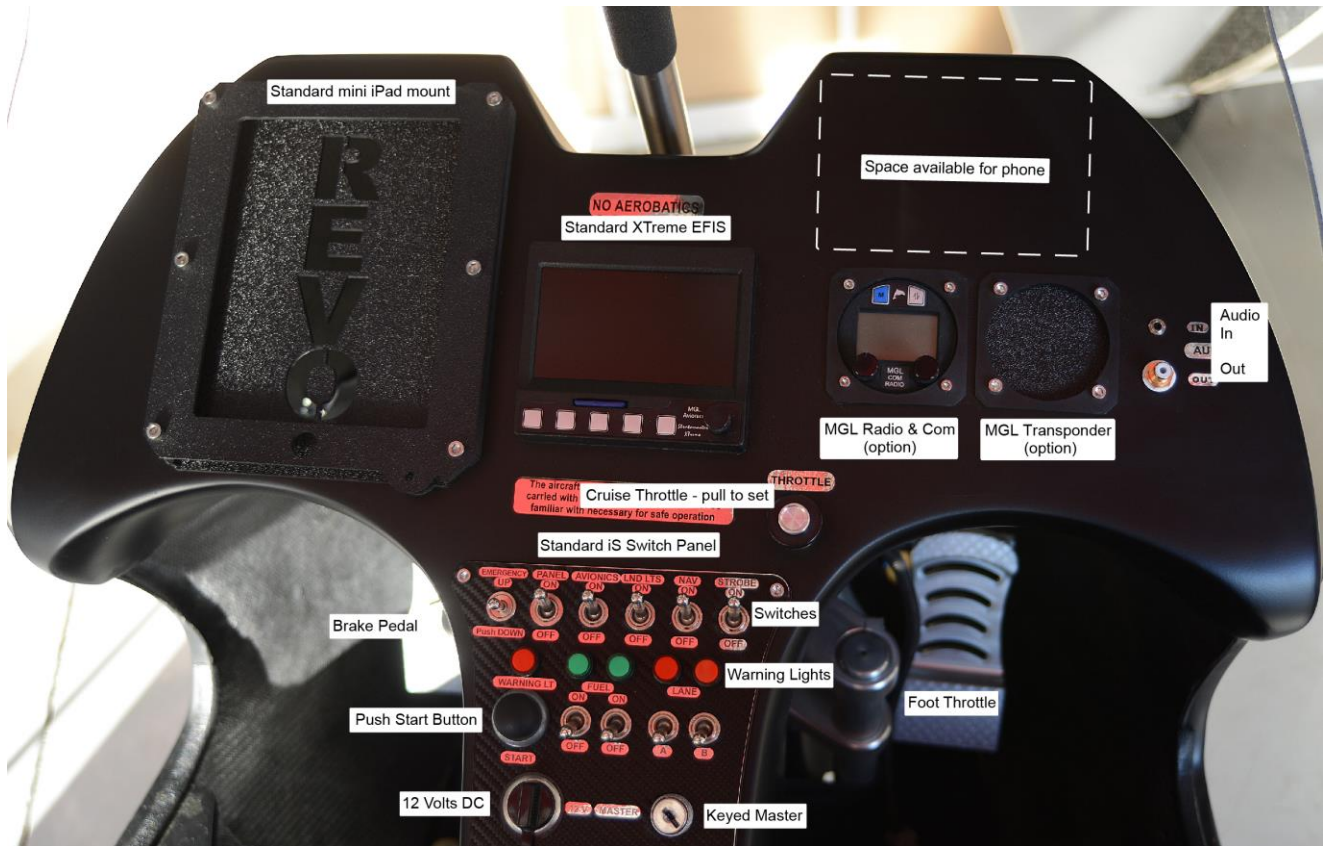

Standard iDash Panel for 912 UL, ULS, iS with iS switch panel

NOTE

Phone mount not included. Mount phone at own risk. Loose items in the cockpit can cause a propeller strike and power failure.

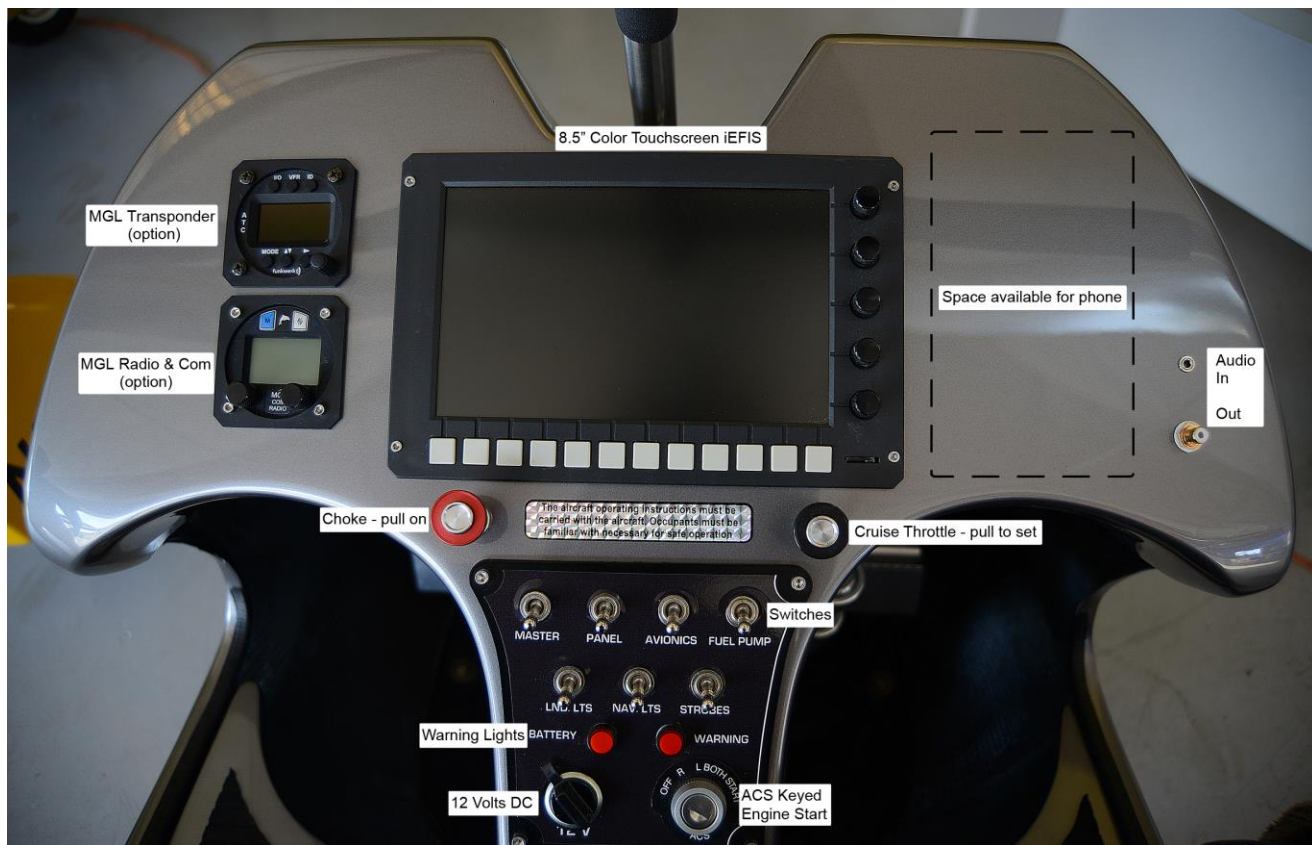

Optional 8.5” Color Touchscreen Panel Layout for 912 UL, ULS, iS with UL, ULS switch panel

NOTE

Phone mount not included. Mount phone at own risk. Loose items in the cockpit can cause a propeller strike and power failure.



Standard Circuit Breaker/ PTT Panel for 912 UL, ULS, iS with the iS switch panel

NOTE

The circuit breaker panel shown is the standard for the 912iS. The standard circuit breaker panel for the 912UL, ULS replaces the BLANK circuit breaker with a FUEL circuit breaker. The PTT panel remains the same for the 912 series.

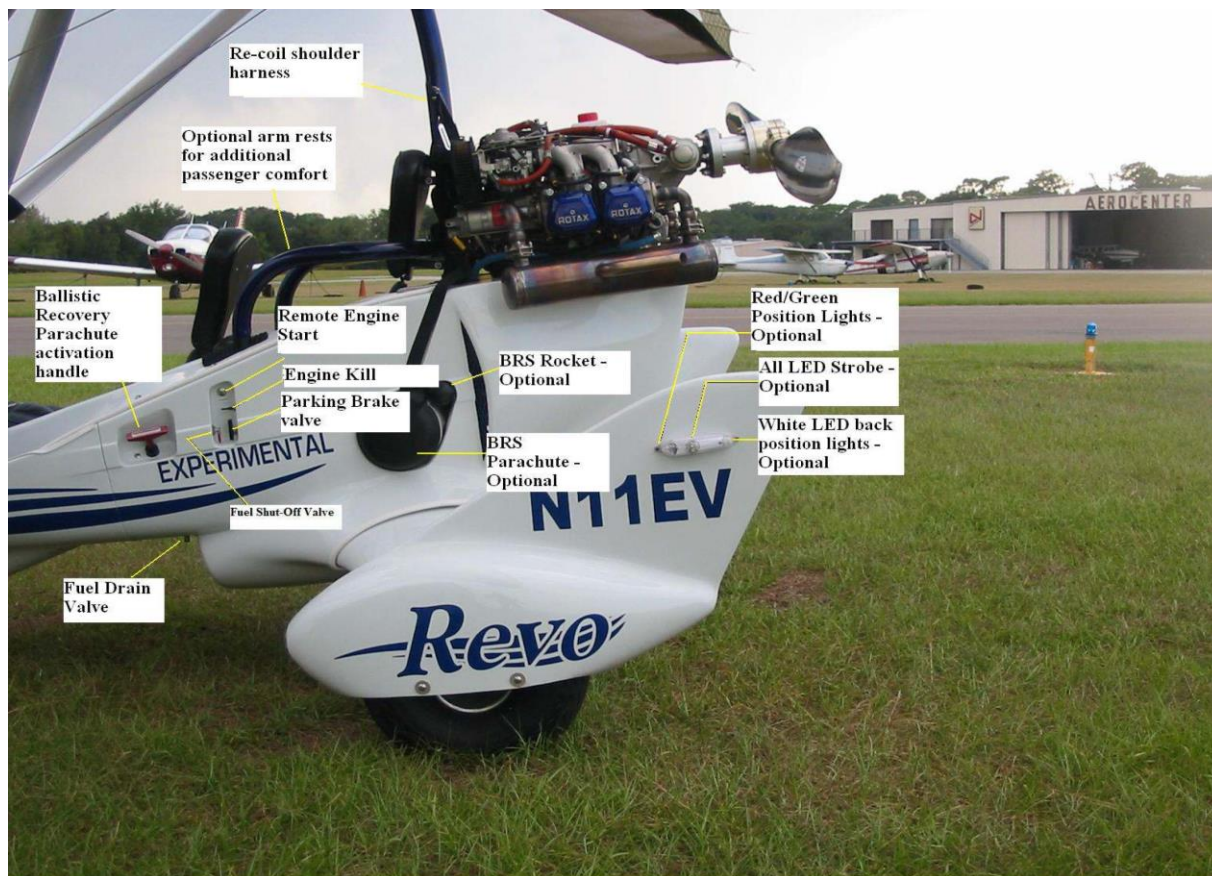



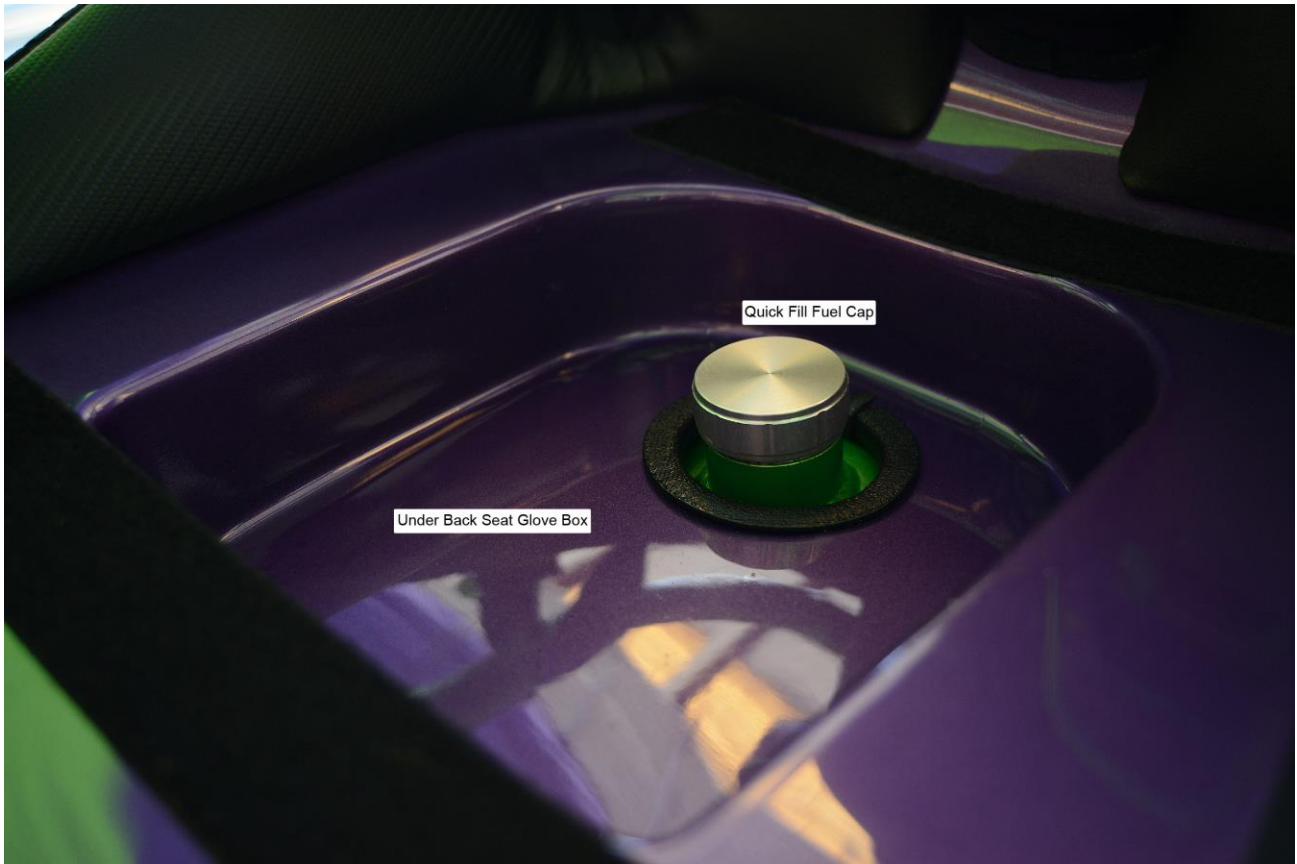

Quick Fill Fuel Access and Under Back Seat Storage

7.2.1 Wing

Evolution Aircraft Inc.'s Revo is available with the following wings:

- 1) Competition
- 2) Reflex Sport (discontinued)
- 3) Discovery
- 4) Rival (discontinued)
- 5) Rival S
- 6) Rival X

For more information on the wing please refer to the wing manual which should be carried along with this POH at all times. A brief description of the wing models is provided here.

7.2.1.1 Competition 11

Competition is a topless trike flex-wing that represents both efficiency and sporty handling with great cross-country flight capability for the Revo aircraft. It surpasses the wing stability and strength requirements set by the ASTM standards for 1040 lbs (472.5 kg). The wing has wide speed range, and maximum speed is achieved without great physical efforts required from the pilot. The wing has also very light in roll handling giving a sporty feel to the pilot. Turbulence can be balanced without extra effort. The wing can be optionally fitted with an electric trim system to set cruise speed while flying. It is a "pilot's" wing and experienced pilots will appreciate its effortless response and sporty feel along with carefree fast cruise speed for cross-country flying and efficiency despite its small size. This wing comes standard with winglets and should not be flown without them.

7.2.1.2 Reflex Sport 12.5

(discontinued)

Reflex Sport is a topless trike flex-wing that delivers a higher aspect ratio, large speed range, good sporty handling that can make beginner to advanced pilot feel confident while providing the fun factor desired by most. Its innovative speed louvers and rubberized vortex generators give it an edge in its class. The gross weight of the Reflex Sport is 1040 lbs (472.5 kg).

7.2.1.3 Discovery 13.5

Discovery is a great general purpose, high altitude and training wing while providing acceptable docile qualities in all areas. Discovery is recommend for beginners to intermediate pilots. The gross weight of the Discovery is 1060 lbs (482 kg).

7.2.1.4 Rival 12.4

(discontinued)

Rival is a suitable first wing, however it has a higher takeoff and landing speed. The gross weight of the Rival is 1060 lbs (481 kg).

7.2.1.5 Rival S 12.4

The Rival S is a suitable beginner wing, however, it has a higher takeoff and landing speed. It carries the highest gross weight we offer at 1160 lbs (526 kg).

7.2.1.6 Rival X 14.0

The Rival X is a suitable beginner wing through advanced. It carries the highest gross weight we offer at 1160 lbs (526 kg).

7.2.2 Carriage



The Revo trike carriage is a two seat tandem WSC aircraft. The layout is typical for two seat trike design, with the pilot, passenger and pod being suspended by a triangular frame made of 4130 aircraft Chrome moly MIG welded and de-stressed to aircraft standards, hanging from the top of the 4130 Chrome moly mast about the pitch and roll axes, to provide for weight shift control.

The cockpit has a quick release windscreen for improved wind deflection and the wheel spats include large integrated aerodynamic fins to improve carriage yaw stability (**WARNING THE REVO CANNOT BE FLOWN WITHOUT THESE**). The mast is 4130 Chrome moly bowed to provide great comfort for the passenger.

The main gear suspension consists of one piece 7075 T-6 Aluminum plate leaf spring landing gear that is covered on either side with aerodynamic composite fairing. The composite fairing body or pod gives the Revo its sleek and sporty look.

The seats are composite bucket seats with molded cushioned attached for comfort and here is a 3-point harness system available to both pilot and passenger with the shoulder harness being a re-coil harness system.

The main wheels are equipped with effective hydraulic disc brakes with hydraulic disc fluid reservoir near the front fork.

There is space for baggage under the front seat on each side of the base tube (center bottom keel tube) of the trike carriage and this space can be further accessed from the front bucket seat by lifting off the Velcro attached cushion and loosening the screws of the bucket seat top surface. Under the back seat is a standard 14.7 Gal (US), 55.6 L fuel tank, securely mounted to the seat frame and keel tube of the trike carriage. An optional 17.5 Gal (US), 66.2 L fuel tank may replace the BRS when none is ordered. Optionally an ASTM compliant model BRS 1050 can be fitted very cleanly inside the trike pod behind the fuel tank. The BRS handle is located on the side of the body well within reach of the pilot.

7.3 Flight Controls

Flight controls are as follows:

- Control bar move right = Left turn
- Control bar push out = Pitch up
- Push right toe = Throttle open
- Hand throttle forward = Throttle open
- Cruise throttle control pulled and foot throttle pressure released = Throttle set in position
- Push trim momentary switch down = CG trim moves to a faster position (with electric trim option only)
- Push trim momentary switch up = CG trim moves to a slower position (with electric trim option only)
- Push roll trim momentary switch right = Trike will roll right (with electric trim option only)
- Push roll trim momentary switch left = Trike will roll left (with electric trim option only)

7.4 Ground/ Flight Control

Ground Controls are as follows:

- Push left pedal = Taxi steering right
- Push right pedal = Taxi steering left
- Push Left Toe = Brakes on
- Ignition key switch to BOTH position = Both magnetos on for 912UL and 912ULS only (note the 912iS uses the key as a master switch)
- Choke (under dash) to ON position = Choke on for 912UL and 912ULS only
- Fuel Shut Off valve to “ON” position = Fuel on

7.5 Instrumentation

The instrument panel consists of a Stratomaster Ultra digital glass cockpit instrument mounted centrally in the dash. The glass cockpit receives its data from an RDAC engine and sender data collection unit located under the top engine cowl of the Revo. A 12V DC outlet and Cessna like keyed mags for pilot and ignition key switch is on the panel (only on 912UL and 912ULS). Other marked switches include landing light switch, strobe (flasher) switch and a master avionics switch. Klixon push-pull circuit breakers are set for all electrical devices. See pictures at the beginning of this section.

7.6 Electric In-Flight Trim Systems

7.6.1 Electric In-Flight Speed Trim

The electric in-flight speed trim is an option that allows the pilot to fly hands off by changing the speed of the wing with the push of a momentary switch. The electric in-flight speed trim shifts the entire hang block fore and aft on the keel. It is important to understand that this system only relieves the pilot's arms from holding the bar in a position that may be different than a fixed hang point trim speed. In **No Way** can it over-ride the pilot's input. To use the speed trim press and hold the momentary switch. Holding down the switch will pull the hang block forward and shift the CG of the wing forward causing it to trim faster. Holding up the switch will allow the hang block to slide back and shift the CG of the wing aft causing it to trim slower.

To set the trim for takeoff first hold the trim switch to full slow for 10 sec. This ensures the trim is at its slowest position and has stopped. Release the slow (up) switch and press down for approximately 3 seconds. This is the ideal start point prior to takeoff. The slowest trim speed setting will not give you the shortest takeoff roll. This is due to the AOI/AOA of the wing being limited by the compression strut a few degrees less than when trimmed in the preferable takeoff trim position. Takeoff in a full fast trim setting will require much more pressure to push the control bar forward. The control bar is the best indicator of where the trim is set when in flight. It is also possible to simply look up and note the position of the hang block between the stops for trim setting.

Setting the trim for landing position is similar to the takeoff position. The preferable trim range for landing is to adjust the control bar until it is approximately 12-14in (.30-.36m) from the compression strut, although any trim position may be used. Landing in full slow trim however, will require more pressure to pull the control bar in. Some back pressure on the control bar may be needed to achieve the approach speed designated in the AOI.

NOTE

The trim position is impossible to detect while on the ground due to the hang block being allowed to float freely back and forth by design. Any trim position is safe for both takeoff and landing. However, there will be additional bar pressure for both takeoff and landing when not set at the ideal position for each.

7.6.2 Electric In-Flight Roll Trim

The design of the electric in-flight roll trim is to eliminate mild turns that show up in flex-wings at different speeds, different loads and different atmospheric conditions. The purpose of this trim system is **NOT** to eliminate standard wing tuning for removing an unwanted moderate turn in the wing or to control the trike in bank. If the wing has a moderate turn, set the trim tabs to center or equal deflection on both sides of the Revo and then tune the wing until there is little to no turn remaining (see Wing Manual). If the wing has a mild turn then using the trim switch will eliminate the turn. Setting the trim tabs is with a flip of a switch. This switch activates a servo driven trim tabs on the wheel spats. This may appear to look like a rudder trim, however due to the floating keel design of a trike, this pressure shifts the keel during flight slightly either left or right.

If the Revo has a mild left turn during flight, meaning the trike banks left when no pilot input is given, press and hold the trim switch to the right until the turn subsides. By pressing and holding the roll trim right, the port side trim tab will activate outwards into the slipstream of air and push the back of the trike to the starboard side. This shift will also push the rear of the keel to the starboard side causing the starboard sail to increase billow and induce a slight right turn. Full deflection of the trim tabs can only produce a maximum force of just under 5 lbs at V_{NE} therefore, the Revo may be flown quite easily in a non-desirable position. These forces are approximately twice the effect of simply turning the nose wheel from side to side during flight.

7.7 Occupant Restraint Harness

The front and rear seats of the Revo are fitted with a 3-point restraint harness system. Both must be used during taxi, takeoff and landing for both occupants. The shoulder inertia reel system is fitted to the mast and requires the strap to be pulled out slowly. Pulling too quickly will lock up the recoil mechanism. Once it is out, the male end of the lap belt goes through the metal slot on the shoulder harness and then by buckling the lap belt the shoulder harness is now secure. To buckle the lap belt the male end is inserted into the female end. When latching the buckle the spring loaded latch is **NOT** pulled. There should be a click heard and felt as the buckle positively locks. Then by tugging on the connection, it can be tested that the buckle is secure. To remove the seat belt just pull on the release handle until it opens approximately 90 degrees and the buckle will release. Please take special care not to allow the heavy metal buckles to fall onto the painted body of the Revo which may scratch the paint.

When flying the trike solo it is important to fasten the rear lap seat belt to prevent contact with hot engine components in flight.

7.8 Engine

The power units available with Revo are: Rotax 912 UL 80 hp, 912 ULS 100 hp, or 912 iS 100 hp. The Rotax engines are a 4 stroke engine designed and built in Austria. The Rotax engine is fitted with a gearbox (2.43:1 reduction ratio), which delivers smooth thrust via a reduction drive. A ground adjustable propeller makes this power unit the ultimate in performance and reliability.

7.9 Carburetor Heating

The 912 UL and 912 ULS engines come equipped with an always-on carb heat, which directs hot coolant to area just around the carb throat. This circulating hot coolant keeps the temperature in the area above the freezing point preventing icing from forming. This system, if equipped, is always on. Power loss is minimal (0.5 to 0.8 HP) and there is no noticeable effect on smoothness of operation.

7.10 Propeller

The propellers approved for use with the Revo aircraft are:

- 1) **Warp Drive Composite** (3 blade ground adjustable pitch – Not approved with Competition combination)
- 2) **Sensenich 69” or 72”** (2 blade composite for 912 series engines as an upgrade option)
- 3) **E-Props** (4, 5 or 6 blade composite for 912 series engines as an upgrade option)

Please see propeller manual for further info.

NOTE

The manufacturer may approve the use of alternative propellers. This approval is only valid when the written authorization from the manufacturer is attached to the POH.

7.11 Brake System

There are 3 wheel hydraulic disc brakes used on this aircraft. Depressing the brake lever on the left hand side of the front footrest engages the brakes on all wheels. Use brakes smoothly and with care. The brake fluid (ATF) reservoir is located under the panel near the front steering fork. The parking brake lever is located on the port side (see picture, page 79). To engage parking brake, depress the left foot pedal (brake pedal) to get desired braking pressure and simply rotate the parking brake valve lever with the left hand. This will engage parking brake.

7.12 Electrical System 912UL, 912ULS (top) and 912iS (bottom)

Below is an electrical diagram for the aircraft:

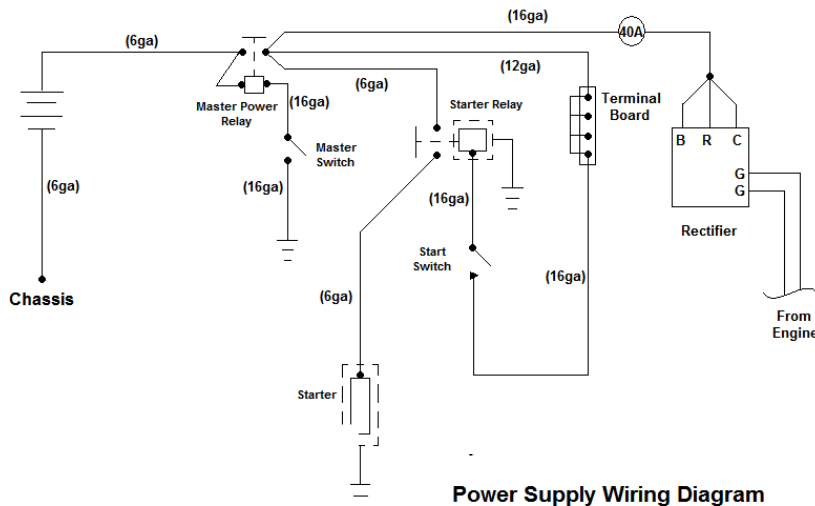

REVO Rotax 912 UL & 912 ULS Wiring

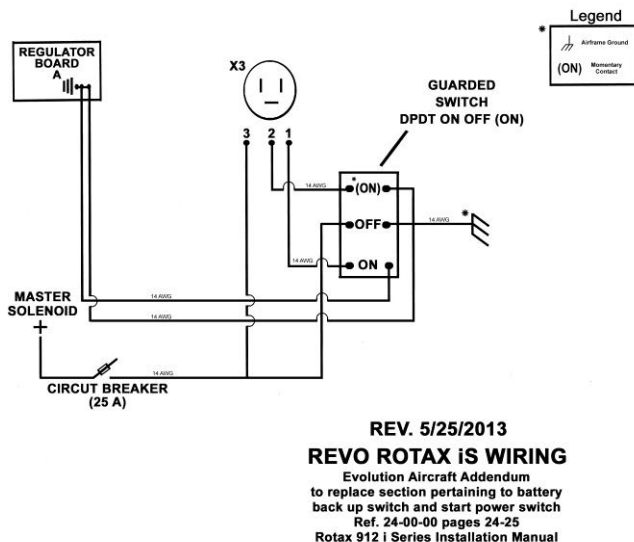

NOTE

The ignition circuit is a fail-safe system whereby the engine will run in the event of the ignition circuit becoming disconnected. Switching the coil to ground stops the engine.

When stopping the 912 UL and 912 ULS engine, turn the ignition key to the off position. Turn the master switch on the dash to the off position and turn additional switches to the “off” position, if applicable.

If necessary, stop the motor by using the choke to flood the engine as mentioned in the emergency procedure section of this manual.

To stop the 912 iS engine either shutting off both fuel pumps or shutting off both lane A and B will kill the engine.

Refer to the Rotax manual for more details for the engine electrical system.

7.13 Pitot Static System and Instruments

The pitot static system supplies ram air pressure to the air speed indicator from the nose

7.14 Stratomaster Ultra Horizon XL Instrument Functions (discontinued)

The Ultra instrument has preset alarm limit thresholds. The “Instrument Alarm” light will start to flash if any of the temperature, pressure or flight speed limitations are reached. Standard instrumentation includes the MGL Electronics Stratomaster Ultra Horizon XL Digital Flight instrument with *“Remote Data Acquisition Computer”* RDAC.

NOTE

The user is required to change the internal calculator battery every 2 years. Please refer to the Ultra manual. Not changing this battery will result in Ultra losing all configurable settings by the user and will go to default values including fuel level calibration

The Ultra Horizon XL lets you define your display and is extremely powerful. The general features are listed below:

- All screen items can be enabled or disabled easily.
- Most screen items have several display options (eg: Altimeter dial, tape, or digital-only).
- All screen items can be **MOVED** around the display for custom layout.
- Up to 4-channels of Thermocouple (**This aircraft uses 2x EGT and 2x CHT**).

7.14.1 Basic System Functions

- Altitude to 40,000 ft (12,195 m) calibrated, 1ft dynamic resolution
 - Airspeed ASI analog and digital, TAS digital
 - Stopwatch
 - Glide and climb ratio to 1/99
 - Altimeter setting 28.30 - 31.30"Hg (QNH 960 to 1060 mb)
 - Quick select standard altimeter 29.92"Hg (QNE 1013 mb)
 - Time of day, Date for flight log entries
 - Air time since take-off (or lesson time)
 - Ambient temperature using external sensor
 - Up to two Fuel levels using flow sender or optional level senders
 - Fuel flow using flow sender
 - Current range estimate (range at current speed and fuel burn)
 - Fuel bingo estimate (time until tank empty)
 - Range calculator using manually entered ground speed
 - Air distance made good
 - Voltage. Supply to unit. Usually 12V battery.
 - VSI +/- 9 990 ft/minute (50.7 meters per second) range
 - Flight log storing up to 200 entries
 - Hobbs meter
 - Density altimeter
 - Barometer for ambient pressure
 - Aircraft registration number display
 - Maintenance timer
 - **Warnings for engine temperature, speed high, speed low, maximum altitude, low fuel level, etc**
 - **Alarm output to switch a warning lamp**
 - Audio alarm output to drive a panel speaker or low level output for alarm tone injection into a suitably equipped headset or intercom system.
-
- Measuring take-off run to 50 ft (15.24 m) above ground level
 - Air talk link for connection to (optional)
 - PC's and Laptops using optional cable
 - Stratomaster 'Black Box' flight recorder
 - Stratomaster Ultra secondary instrument
 - Stratomaster Ultra secondary instrument
 - Download keyring flight log device
 - Compass and AHRS sensor packages



NOTE

For more information on using this instrument please refer to the Stratomaster Ultra Horizon XL, and RDAC manuals.

WARNING
It is prohibited to fly with the EFIS Alarm thresholds set outside the engine manufacturer's limits or to set the V_{NE} and V_{SO} limits different than what is listed in this manual.

=

7.15 Color EFIS + Aviation GPS (Stratomaster Enigma) (discontinued)

Aircraft can be fitted with a color glass EFIS which has an aviation moving map GPS built-in. This EFIS is capable of fully programmable multi-screen display.

NOTE

It has an internal calculator battery that should be changed by the user every 2 years. Please refer to the EFIS manual. Not changing this battery will result in EFIS losing all configurable settings by the user and will go to default values including fuel level calibration.

7.15.1 General Wiring Hook-Up Diagram

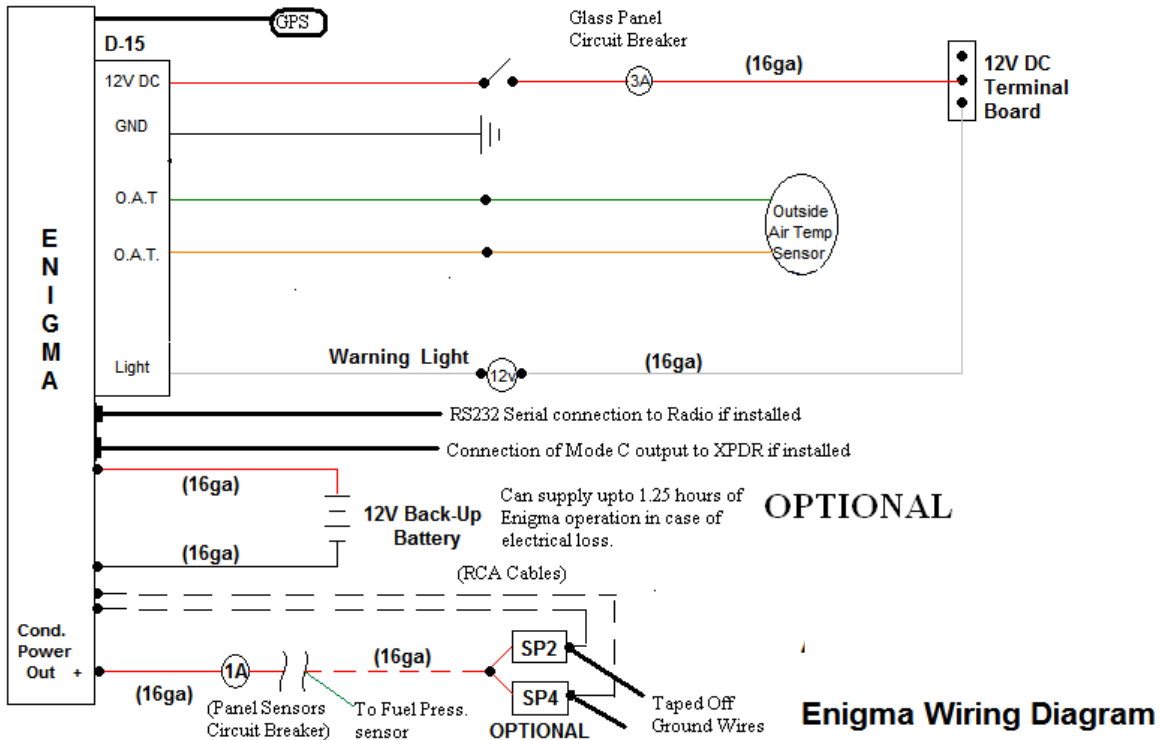



7.15.2 Glass Panel (Enigma) Start- Up Quick Reference

7.15.3 Screens 1 through 5

The following apply to all screens and explain various terms used on the screens. The manufacturer is only concerned with and supports the first 5 screens of the EFIS. The user is not allowed to change the first 5 screens of the EFIS. The user can change or customize screens 6,7 and 8 using the simulator program for the EFIS. The manufacturer will not explain nor support these changes.

OILP = Oil Pressure

OILT = Oil Temperature

CHT = Cylinder Head Temperature (x 2)

EGT = Exhaust Gas Temperature (x 2)

Fuel (Tank) = Fuel Quantity indicated by Fuel Level sender fitted in the gas tank

Fuel (Calculated) = Fuel Quantity calculated by using the Fuel Flow sensor. This fuel being used as indicated by Fuel Flow sensor is subtracted from this Fuel (Calculated). Pilot should update the Calculated Fuel level whenever he/she fills fuel in the fuel tank. This is done by:

- a) Hitting Menu
- b) Selecting Fuel Level Calculated RDAC 1
- c) Updating the fuel level to however much pilot believes is in the fuel tank

TAS = True Airspeed

DA = Density Altitude

HDG = Magnetic Heading

ETA = Estimated Time of Arrival

ETE = Estimated Time En-route

GS = Ground Speed (from GPS)

Dist = Distance to selected waypoint or airport

Flight Time = How long the flight has been conducted for so far

HITS = Highway In The Sky

ALT = Altitude

ASI = Air Speed Indicator

TRK = Track

Units of measurement can be changed in EFIS Menu settings to metric system units. Please refer to EFIS manual for details. The system time and date should be updated by the user on receiving the aircraft.



Glass Panel Start-Up VFR screen

Simple VFR screen with ASI on top left, Altimeter on top center, magnetic heading indicated by HDG, VSI on top left, Engine monitoring bar graphs bottom right, Fuel level and calculated fuel level in bar graphs to the left of engine monitoring bar graphs, Tachometer (RPM) center bottom with Hobbs and Fuel flow shown right underneath it, Info screens bottom left.

The Kollsman window (inside the dial altimeter) showing the pressure can be adjusted by using the up and down arrow buttons (Baro+ and Baro- respectively).

NOTE

That each screen has multiple info screens always on bottom left and these can be cycled by hitting left or right arrow buttons on the keypad.



Glass Panel Number 2 Variation

An EFIS screen with magnetic heading top dead center, Altimeter tape on right with climb rate in a black rectangle at its bottom and Kollsman window at its top, ASI tape on its left, with ground speed rectangle at its top and true airspeed rectangle at its bottom. All engine monitoring, tech, fuel flow on the bottom. HITS box can be shown also on this screen.

The arrow inside a black circle shown next to ground speed (Gs) is a wind arrow that indicates the direction of the wind relative to aircraft's heading or relative to north (can be configured either way in the menus of the EFIS).

NOTE

That each screen has multiple info screens always on bottom left and these can be cycled by hitting left or right arrow buttons on the keypad.



Glass Panel Number 3 Variation

A split screen with a typical EFIS screen shown on the top left (similar to screen 2), a moving map GPS screen shown on top right and engine monitoring and info screen on the bottom half.

The 4.0mi indicates that the moving map is showing a 4 mile view of the map. A user can use the “Log”(+) and “Hold”(-) zoom buttons to zoom in and out of the moving map.

The arrow inside a black circle shown on the top right corner of the moving map split screen is a wind arrow that indicates the direction of the wind relative to aircraft’s heading or relative to north (can be configured either way in the menus of the EFIS).

NOTE

That each screen has multiple info screens always on bottom left and these can be cycled by hitting left or right arrow buttons on the keypad.



Glass Panel Number 4 Variation

This is a GPS moving map based screen with magnetic heading shown top dead center and ASI tape and altimeter tape shown on the left and right respectively. The 4.0mi indicates that the moving map is showing a 4 mile view of the map. A user can use the “Log”(+) and “Hold”(-) zoom buttons to zoom in and out of the moving map.

All the engine and fuel monitoring features are shown at the bottom in this screen configuration.

The arrow inside a black circle shown next to ground speed (Gs) is a wind arrow that indicates the direction of the wind relative to aircraft’s heading or relative to north (can be configured either way in the menus of the EFIS).

NOTE

Each screen has multiple info screens always on bottom left and these can be cycled by hitting left or right arrow buttons on the keypad.



Glass Panel Number 5 Variation

A screen showing just the moving map view for the GPS with track, ETE, ETA, Distance, ASI and ALT in rectangles around the screen.

The arrow inside a black circle shown on top left is a wind arrow that indicates the direction of the wind relative to aircraft's heading or relative to north (can be configured either way in the menus of the EFIS).

7.15.4 Common EFIS GPS Usage

The following sequences describe the most common GPS function usage of the Enigma EFIS. This is by no means a full narrative on how to utilize the capabilities of the EFIS for which the user is directed to read and understand the EFIS manuals and if necessary ask technical questions in writing from MGL Avionics support.

7.15.4.1 List of Closest Airports and Activating Airports Database

Press 0. If no airport is already selected and no route is active, this will bring up the list of the closest 8 airports to the current location. If an airport is selected it will bring up information about currently selected airport and while on this screen pressing “Enter” will bring up closest airports and airport database browser.

NOTE

To learn more about ROUTES please read the EFIS user manual. Having an active route will show the airports in your route when “0” key is pressed.



Each entry shows an arrow indicating which direction to fly relative to your current heading to intercept the airport. If the arrow points straight ahead, continue your current track.

Next is the distance to the airport (using distance units as selected for your instrument in “units setup”). Next, an approach, tower or Unicom frequency is shown if defined in your airport database. If no frequency is defined, “No Freq” is shown.

This is followed by a primary and, if available, a secondary runway designation. Selecting any of the eight airports results in the following display:



Shown are all defined frequencies for your selected airport (and the nominal airport altitude above MSL). If you have a compatible communications radio connected to your EFIS, selecting any of the frequencies will set your radio to that frequency.

Next, the defined runways are shown with designation, surface type (Asphalt in this example), length and width.

 GOTO this airport Use of “Enter” here will set your EFIS’s GPS navigation to this airport

7.15.4.2 How to Use Airports Database Browser or Search for Airport by Identifier

Airport database browser can be accessed from the closest airports list (see previous section) by hitting “9”.



You can simply browse this browser list by using up or down arrows and find the airport you are looking for. Airports here are listed in order for distance from the current location. Once the desired airport is found by the user, the user can select that airport by pressing the corresponding “number” on the keypad and select to go to that airport via GPS navigation of the EFIS.

Alternately, the user can decide to use “Shift + 1 (Goto)” keys to bring up the browser. In both cases, instead of browsing using up and down arrows, user can elect to “Search for airport” by using the “LOG” key on the EFIS keypad. This presents you with an entry field where you can enter the desired ICAO compliant airport designator, for example “KLAX” for Los Angeles international airport. If the airport exists in the database, you will be presented with the airport details.

7.15.5 EFIS COM Radio Control

If you have one of the following VHF radios you can select the VHF communications frequency directly from your EFIS airports database.

MGL Avionics VHF COM radio (V10) or (V6)

Before you can operate any of these radios, ensure that the radio is correctly wired to RS232 port 1 (on the back of the EFIS) and select the radio type you are using in “Operations setup”.

Press “0” from any main screen and select the airport from the list of closest airports to your current location or use the airports browser.

If your airports database has information on frequencies for the selected airport, these are shown in a list like the one shown here for Cape Town International.

Press the button indicated next to the desired frequency to select it in your COM radio.

Frequencies for FACT (150ft)					
1	TWR	118.100	200		
2	APP	119.700	200		
3	ARSA	119.700	200		
4	GND	121.900	200		
5	GTE	122.650	200		
6	ATIS	127.000	200		
Runways for FACT					
7	01/19	ASP	L: 10502ft	W: 200ft	NO APP
8	16/34	ASP	L: 5581ft	W: 151ft	NO APP
↑ Previous page ↓ Next page Ent GOTO this airport					

NOTE

All selections will be done to the active frequency in cases where the radio supports both active and standby frequencies. Each time you press a frequency selection button, the corresponding selection message is sent to the radio.

7.15.5.1 Using the “Radio” Page to Set Frequencies Not Related to an Airport

Pressing “SHIFT”+”2” (Radio) shows the Radio page. Here you can place up to 10 radio frequencies for quick select. Typically, you would have area frequencies on this page. Page 112 Stratomaster EFIS – User’s manual.

Frequencies and description are stored in a simple text file that you can create yourself (using Notepad or similar) with a filename of "radio.txt". Please use a simple text editor to create a normal ASCII text file. Do not use files created by Word processing applications unless they can export to a simple text file.

Example radio.txt file:

Use the text between the dashed lines, don't include the dashed lines.

```

-----
;Example frequency list for SHIFT+Radio function
;First entry is frequency in MHZ in the following formats
;123
;123.0
;123.5
;123.45
;123.425
;This can be followed by a space and then text up to 30 characters for a descriptor
;Lines starting with a ";" are comments (like this line)
;You can enter up to 10 frequencies
124.8 VFR below 1500 AGL
124.4 General flying area
123.45 Chat frequency
-----

```

Copy the file onto your internal solid state disk using the "File manager" (see **EFIS manual**). Copy the file into the “Other” folder.

If you have a compatible radio, you can set the active frequency directly from the radio page. If you don't have a compatible radio, it's still useful if you need to look up a frequency.

7.15.6 SP-2 Magnetic Compass Heading Navigation and Calibration

The aircraft is equipped standard with SP-2 sensor for the EFIS that is connected to the back of the EFIS (not via RDAC). This sensor provides “Magnetic” heading. This sensor is located under the pilot seat just to the right. The sensor is simply “Velcroed” on to the inside of the body and can be moved by the pilot.

NOTE

Treat the magnetic heading from the EFIS the same way as any magnetic compass. No difference. This is -not- a GPS based heading. It in fact is a solid state magnetic heading indicator not related to the GPS at all.

You may want to get deviation calibrated as much as possible before doing long cross country flights or once a year or so or if you have changed the EFIS unit.

Deviation compensation consists of entering deviation compensation mode through the Menus in the EFIS and rotating your aircraft through at least one full 360 turn on the ground away from metal buildings. The SP-2 must during this procedure remain horizontal to the Earth's surface.

Once the turn is completed you need to end the deviation compensation procedure. It is also possible to clear any deviation compensation and return the unit to factory calibration.

NOTE

Be aware that many concrete reinforced aircraft aprons or runways may contain significant amounts of iron which may make it impossible to perform any meaningful deviation compensation on these surfaces. Also, do not attempt to calibrate your compass inside a hanger that contains significant amounts of iron based metals as part of the construction.

Proceed as follows:

- 1) Get trike away from metal buildings and objects.
- 2) Turn EFIS on.
- 3) Turn on all radios, transponders and electrical devices. Engine is NOT running
- 4) On EFIS keypad do the following: Menu -> Menu -> Page Down (down Arrow) -> Setup
Compass Sensor -> Start Deviation Compensation -> Press "1" to accept Continue
- 5) Now lift the nose of the aircraft only a couple of inches (no more) and rotate the aircraft through 360 degree turns twice. Stopping at the same heading where you started.
- 6) Let the numbers on blue screen settle in a bit
- 7) Press "Enter" to accept Deviation Compensation
- 8) You can press "Enter" on Enigma keypad to get out of this menu

To get more accurate calibration on compass rose, you can do this further step:

- 1) Taxi your trike to an airport Compass Rose. Many airports but not all have these painted showing North, South, East and West.
- 2) Have all electrical devices turned on and the engine running.
- 3) On EFIS keypad do the following: Menu -> Menu -> Page Down (Down Arrow) -> Setup Compass Sensor.
- 4) Line up aircraft North on the painted compass rows. Press the number on the Enigma screen that says "Lineup North". Press "1" to Set.
- 5) Line up aircraft South on the painted compass rows. Press the number on the Enigma screen that says "Lineup South". Press "1" to Set.
- 6) Line up aircraft East on the painted compass rows. Press the number on the Enigma screen that says "Lineup East". Press "1" to Set.
- 7) Line up aircraft West on the painted compass rows. Press the number on the Enigma screen that says "Lineup West". Press "1" to Set.
- 8) You can press enter to get out of this screen and menu.
- 9) That's it. That should give you a very accurate magnetic compass heading. You may want to repeat the deviation compensation once in a while. There is an option to clear current deviation compensation in Compass setup Menu also. This should also be done when the EFIS unit is replaced under warranty or due to malfunction.
- 10) Test your compass new deviation compensation by lining up on runways or on compass rose to see if the heading shown seems to correspond. If they don't correspond it may be that the SP-2 compass sensor has started getting some ferrous interference. The ferrous interference may need to be removed. In the trike, it is easier to move the SP-2 sensor to a different location because it is simply Velcroed down with industrial strength Velcro.

NOTE

For more information on using this instrument please refer to the Stratomaster Enigma EFIS and RDAC manuals.

7.16 XTreme EFIS (Standard Equipment)

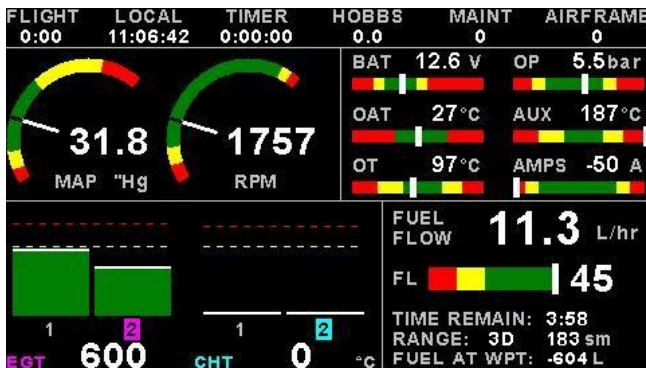

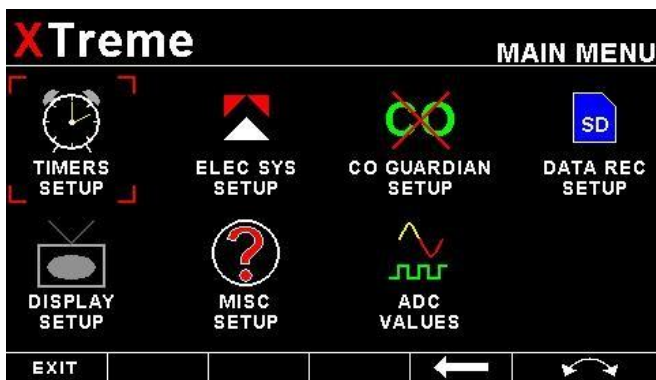
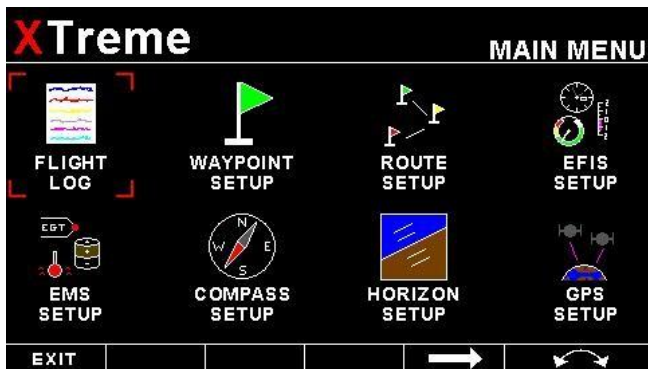

The XTreme EMS is used when the 912 IS is chosen. It is a 4.3" sunlight readable, wide viewing angle, high resolution LCD display. It integrates an SD card reader (for software updates and for engine data recorder), 5 function buttons, a rotary control.

It is connected to the standard MGL Avionics RDAC (same as the Enigma). Reference the MGL EFIS manual for further details

http://www.mglavionics.com/XTreme_EFIS_Manual.pdf

7.17 Explorer 8.5" iEFIS (Option for 912 UL, ULS & iS)



The 8.5" Explorer iEFIS is an option for all 912 engine configurations. The iEFIS utilizes a custom developed, pressure sensitive, sunlight readable touchscreen that can also be operated using gloves. The iEFIS screens can be completely edited by the user using a simple PC program to create various displays.

Reference the MGL iEFIS manual for more information.

<http://www.mglavionics.co.za/Docs/iEFIS%20primer.pdf>

7.18 Secondary Engine Kill Ignition Switch for the Back Seat

The secondary ignition switch is located on the trike pod on the left hand side easily reachable by the back seat occupant when needed. The switches momentary and must be held until the engine comes to a complete stop. This is done to prevent an accidental engine shut off by the back seat occupant.

When the kill switch is engaged, the switch shorts the engine coils to ground causing the engine to stop. Pulling up on the engine kill switch or pushing down on it will kill the engine within a short time.

7.19 Ballistic Recovery Systems (Parachute) - Optional

NOTE

The parachute is optional equipment.

The BRS emergency parachute system has a double acting firing mechanism. The parachute operating handle is fitted with a safety pin and is located on the left side of the cockpit dash. This pin should be removed before each flight and the safety pin must be replaced before the pilot gets out of the aircraft. A force of approximately 30 lbs (13.5 kg) pull on the actuating handle is required to activate the BRS rocket motor. Emergency procedures for use of the BRS can be found in emergency procedures section of this manual. Additional information including service and maintenance requirements can be found in the BRS manual.

WARNING

There is no guarantee of any kind that BRS will always work in all circumstances of an emergency in saving the occupants life. The BRS should be used as a measure of last resort.

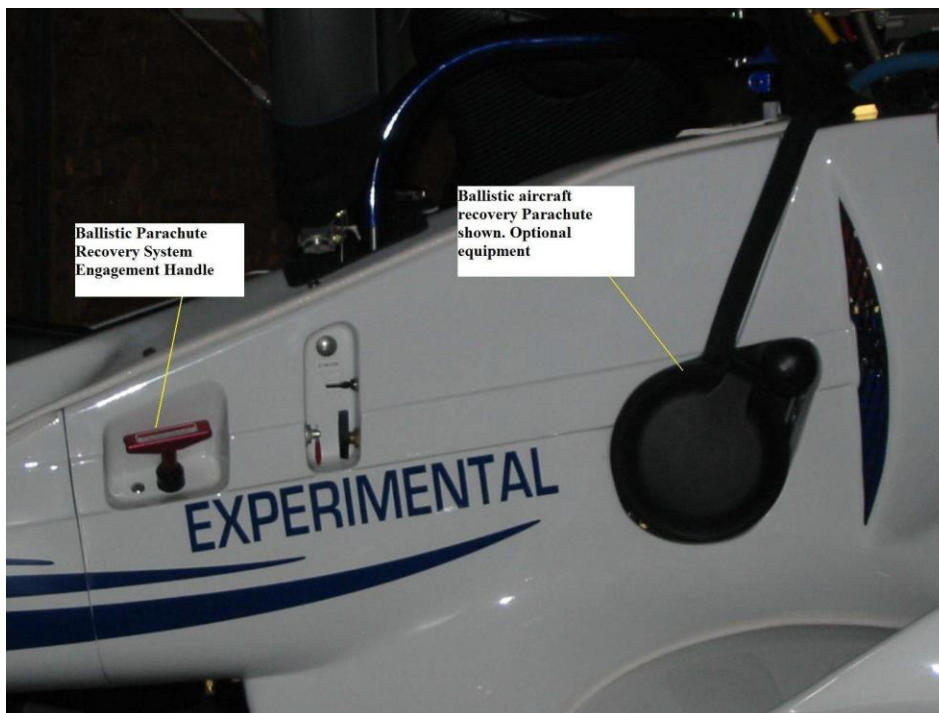

8 Handling, Servicing and Maintenance

8.1 Introduction

This section contains factory recommended procedures for proper handling and routine care for your Revo weight shift control aircraft. Included in this section is relevant information required by the operator.

WARNING

It is the PIC's responsibility to ensure compliance with all airworthiness directives and that all required and recommended service and maintenance have been performed as listed in the relevant maintenance manuals of the wing, aircraft and the engine, in accordance with applicable regulations.

8.2 Identification Plates

The identification plate is located on the right back side of the aircraft. The wing's identification plate and serial number will be located on the wing tubing. Serial numbers, model name and date of manufacturer for both trike and wing should be used when corresponding with the factory.

8.3 Documents

This POH or AOI is one in a series of documents for the aircraft. Other documents include:

- Wing(s) manual
- Propeller manual
- Engine Owner's Manual
- Engine Installation and Maintenance Manual
- Stratomaster manual(s) for instrumentation
- RDAC or Remote Data Acquisition Computer Manual
- Fuel Flow Sensor Manual
- Maintenance and Inspection Manual
- BRS Owner's Manual (optional)
- Radio or Transponder Operators Manual (optional)

These manuals should be consulted for information not included in this manual.

8.4 Aircraft Inspection, Maintenance and Repair

Qualifications for the person doing the maintenance vary from country to country. The operator/mechanic should be familiar with the local requirements. Maintenance requirements are outlined in the maintenance manual for the base unit and in the wing manual for the wing and for engine maintenance refer to the engine manuals.

NOTE

To protect hardware from elements it is highly recommended that a water displacement compound like ACF-50 or something similar be used from time to time to clean and prevent galvanic corrosion. This can be done by the owner. Excess should be wiped off immediately after application. Alternately, compounds like Bo-Shield sprays, after replacement of hardware, can be used as they make a waxy film around the metal and protect it from the elements for up to 6 months or as advertised. Treating engine with WD-40 or another water displacement compound also makes it easier to clean and maintain engine's appearance. Excess should be wiped off with a soft cloth.

8.4.1 Hangbolt Replacement

Hangbolt (AN-8 aircraft grade) should be replaced every 400 hrs with a bolt supplied by either Evolution Aircraft Inc. or a reputable AN bolt supply house.

8.4.2 Mast Bolts and Nuts Replacement

Mast bolts and nuts should be replaced every 1000 hours with a bolt supplied by Evolution Aircraft Inc. or with an equivalent AN aircraft bolts.

8.4.3 Engine Mount Bolts and Nuts Replacement

Engine mount bolts and nuts should be replaced every 400 hours or on condition with hardware supplied by Evolution Aircraft Inc. or aviation grade bolts of the same size from an aircraft or ULM factory.

8.4.4 Wing Hardware Replacement

Generally anything in the wing that looks suspicious should be replaced immediately with hardware supplied by the manufacturer or an aviation hardware source before continuing flight. For further information please refer to the maintenance manual. Wing hardware is all AN grade aviation hardware.

8.4.5 Wing Sail Condition

If there is any doubt as to the wing sail condition of a tear or stitching coming apart, it is recommended that you refer to the maintenance manual or authorized sources of information about your wing or the manufacturer (Evolution Aircraft Inc.) and not fly the trike until proper evaluation of the condition can be made.

8.4.6 Propeller

Refer to the propeller manual.

8.5 Fuel System

Please refer to section [4.6](#)

8.6 Engine Oil Replenishment

Please refer to the engine manual

8.7 Engine Coolant Replenishment

Use 50/50 DexCool coolant. For further info please refer to the engine manual. We do **NOT** recommend using Evans waterless coolant for the Revo.

8.8 Tire Pressures

Tires should be inflated to about 20 - 25 psi for both front and back tires.

8.9 Hydraulic Brake Fluid

Revo uses 5606 aircraft red brake fluid. This is the same as red automatic transmission fluid (ATF) found at auto stores. It should never be mixed with DOT brake fluids.

8.10 Front Shock Absorption

Front shocks should not be compressed over 1" while empty. If sagging please contact the manufacturer to replace internals inside the front fork tubes that provide shock absorption to the front.

8.11 Electrical Circuit Breakers and Battery

There are marked circuit breakers present in front of the pilot in this aircraft. A main charging circuit breaker (25 Amps) is also located in front of the pilot. If this circuit breaker pops, a check of the charging circuit per Rotax charging diagrams should be carried out. The Battery is also located near the back of the aircraft and can be accessed by taking off the aft lower cowling of the aircraft.

8.12 Parking, Moving on the Ground and Storage

Make sure area is clear, ignition is Off and if applicable BRS safety pin is in before moving the aircraft on the ground manually.

While moving the aircraft take care to not put weight or excessive pressure on the front fiberglass or engine cowlings. Before moving, the aircraft secure the wing's A-frame and move carefully negotiating the wind direction with the wing's position.

Pulling the trike: Moving the base (with or without the wing) is facilitated by lifting the front wheel and walking the base. Do not pull excessively hard on the compression strut or nose strut of the aircraft carriage. If a hard pull is needed, its best to push the aircraft from the prop hub (back) near the root of the blades. Steer the trike while manually moving by pushing the nose wheel or front steering in the desired direction. Alternately, the front wheel can be placed on a castering support and steered freely.

Pushing the trike: The trike can be pushed using the prop hub near the root of the blades on even surface. Steering is slower and harder using this method except when using castering support on the front wheel.

Parking: Parking the aircraft requires parking brake and using chocks and securing the wing with the upwind wing down. In higher or gusty wind conditions, the wing and trike carriage should be tied down or if appropriate wing can be taken down or the trike should be moved indoors. Please refer to section 4.8.12 for further information.

NOTE

The trike carriage or base can be moved with or without the wing.

Long term Storage: Long term storage will require the supplied air filter(s) be covered to prevent foreign objects getting in the air intake area. Full covers for the carriage and prop blades are advisable, which are available items from Evolution Aircraft Inc. Disconnect the terminals of the battery, and drain fuel from the tank. The engine manual should be consulted for long term storage practices for the engine. Refer to section 4 for further information for storage

NOTE

Do not store the trike outside for any appreciable length of time where it is exposed to the elements. This may reduce life of the sail and other items.

8.13 Transporting the Aircraft

Custom or flatbed trailers can be used to transport the aircraft if they are capable of securing the carriage properly. A carriage cover and propeller cover should be used to minimize damage from flying debris. Propeller blades should be tied in place with soft straps so they are not allowed to move in the air. Propeller blades should never be moved more than a half rotation in the opposite direction to the general direction of rotation of the engine. The wing should ideally be transported fully packed separately for very long distances. For short distances it is not necessary to completely disassemble the wing. Please refer to section 4 for further information.

8.14 Cleaning

8.14.1 Windshield

The windshield is made from flexible Lexan material and therefore a certain amount of care is required to keep it clean and in good condition. The following procedure is recommended:

- Flush with clean water to remove excess dirt, bugs and other loose particles. Wash with mild detergent and warm water. Use a soft cloth or sponge. Do not rub excessively.
- Rinse thoroughly, and then dry with a clean moist chamois. Do not use volatile solvents such as gasoline, alcohol or most commercial window cleaning sprays, as they will adversely affect the plastic.

8.14.2 Painted Surfaces

The painted exterior surfaces of the aircraft can be washed using a mild detergent and water, alternatively an automotive liquid detergent may be used. Soft wax polish applied with proper procedure is recommended every 4 mths on painted surfaces to maintain luster and protect the paint.

8.14.3 Engine

An engine and accessories wash down should be performed regularly to remove any oil, grease, and other residue. Periodic cleaning allows proper inspection of the engine components and can be an aid to discovering defects during inspection as well as reducing the potential for an engine fire during aircraft operation. The engine may be washed down using a suitable solvent, and then dried thoroughly. During cleaning, the Air intakes, BRS parachute, and the electronics should be protected with a thin plastic film like saran wrap.

8.14.4 Propeller

The propeller should be cleaned occasionally with water and a mild detergent with a soft cloth or sponge to remove dirt, grass and bug stains. The opportunity should be taken to visually check the condition of the propeller during cleaning.

8.14.5 Upholstery and Interior

The Pod area should be vacuumed out to remove all loose dirt/gravel etc. All Care should be taken to not spray any substance that will degrade the webbing material, vacuuming is recommended for the upholstery. Alternately, seats can be taken off easily (Velcro) and washed with mild detergent and water.

WARNING

Do not use gasoline or any highly flammable liquid for any wash down or cleaning. Do not wash a hot engine. Wait for it to completely cool off. Perform all cleaning in a well ventilated area and take proper precautions for the materials used.

CAUTION

Precautions should be taken so that cleaning agent or water does not damage electrical circuits. Electrical components should be protected before using any solvent on the engine. All fuel, air and electrical openings or components on the engine should be covered before cleaning the engine. Caustic cleaning agents should be first tested before being used on a larger area.

8.15 Approved Sources of Information and Maintenance

The following are the approved sources for further information regarding maintenance:

- Evolution Aircraft Inc. (<http://www.evolutiontrikes.com>)
- MGL Avionics. South Africa (<http://www.mglavionics.co.za/>) (Stratomaster Instrumentation) or <http://www.mglavionics.com> (USA distributor)
- Warp drive Propeller USA for Warp Drive prop maintenance and technical support
- Sensenich Propeller for optional Sensenich prop maintenance and technical support (<http://www.sensenichprop.com>)
- Aero-Tuff USA (<http://www.aero-tuff.com>) (Seatbelts)
- Rotax Austria and its authorized representatives (<http://www.rotax-aircraft-engines.com/>)

For a list of who is allowed to do non-preventative heavy maintenance and annual inspections on this aircraft please refer to the maintenance manual.

9 Supplement

9.1 Placards

The placards on the aircraft are designed to provide information on the safe operation of the aircraft. This placard sheet may be ordered from the manufacturer using Part #PL003

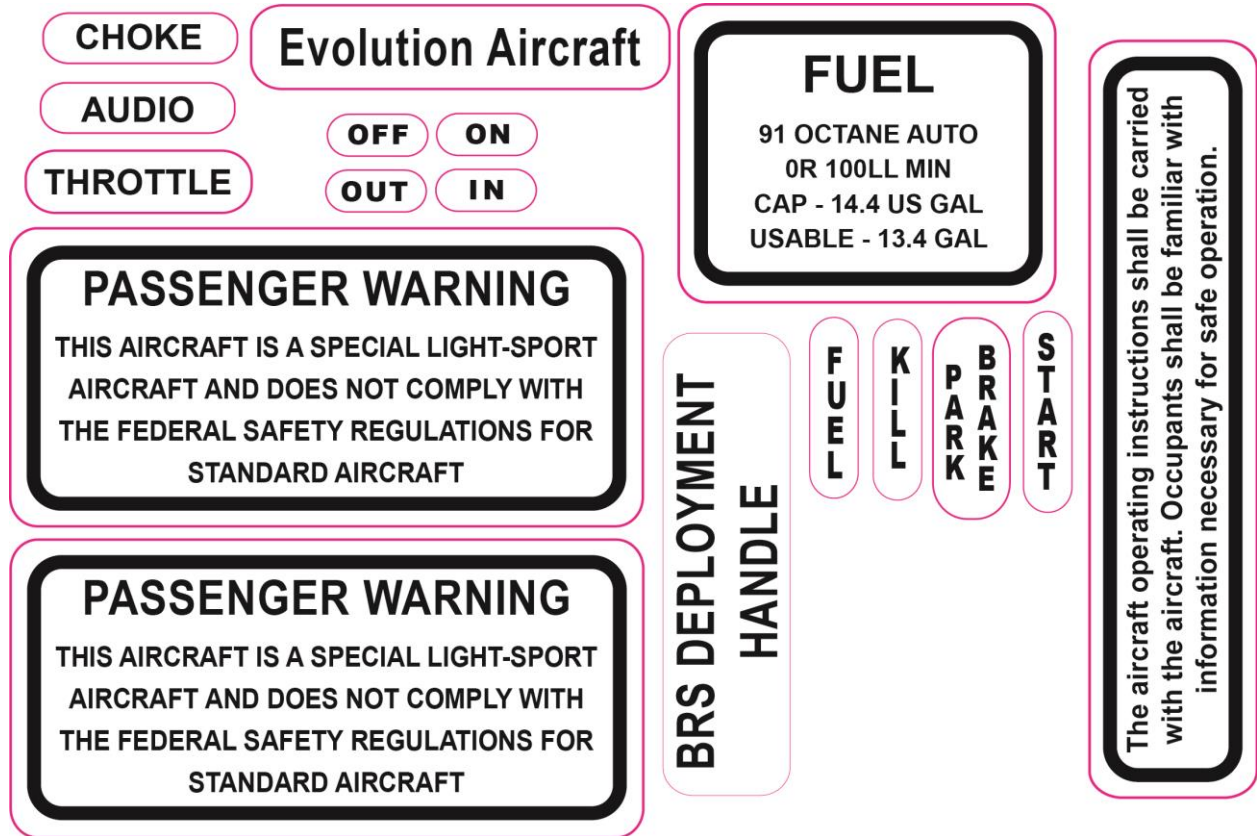

Part #PL003

10 Data Location and Contact Information

In the case that the original manufacturer loses its ability to support this aircraft make and model, the following resource can be used to recover certification information. This resource will supply information for sub-assembly providers and parts supplies to provide support for the aircraft fleet on an on-going basis.

Name	Position/Significance	Contact Information
Phil Mednick	Company Officer	Mflyinlo@aol.com

11 Setup and Breakdown

Please refer to Section 4.9 for separating the wing from the trike carriage. Refer to Section 4.10 for the wing breakdown procedure. Refer to Section 4.11 for information on the transportation and storage of the trike.

12 Flight Training Supplement

12.1 Discovery 13.5 Wing

The Discovery 13.5 wing has no unique characteristics or special training required specific to this combination of wing/carriage.

12.2 Reflex Sport 12.5 Wing (discontinued)

The Reflex Sport 12.5 wing has a somewhat abrupt stall depending on how it is tuned. Take special care not to stall this wing with the nose raised/whip stall. As this should be avoided with any wing it is potentially **MORE** hazardous with the Sport 12.5. Also when landing it is possible to tip stall (one wingtip will drop first) and high flare heights should be avoided.

12.3 Competition 11 Wing

The Competition 11 wing is recommended for advanced pilots due to its quick release of energy on landing especially when loaded over 900 lbs. Airspeed must be managed very carefully when landing the Competition wing. Failure to do so can result in either inadvertent stalling or the inability to stop the descent during landing approach.

Due to the wing loading of this combination it is important to push the control bar forward to the front strut to initiate lift off. Failure to do so will cause excessive speed build up on the ground and create an abrupt swing through which can cause temporary loss of pitch control after liftoff. The takeoff ground roll on pavement for the Competition 11 wing varies greatly based on many factors such as weight, HP, atmospheric conditions and tuning. (see the Revo AOI for performance figures on the Revo carriage). Taking off in grass, downwind, uphill, or with a crosswind especially coming from over tree tops will further increase the takeoff distance well beyond many pilot's estimates, so be sure you have more than enough runway. It is important to get to a safe climb out speed before leaving ground effect which is around a control bar position no closer than 9" from the front strut. It is advised that as speed builds up the pilot leans forward out of the seat with their back straight in order to keep a bend in his/her arms (no locked elbows). Push the bar forward **ALL** of the way to touch the compression strut of the trike carriage **PRIOR** to lift off speed and then wait for the nose to lift as speed increases. As the nose wheel lifts, pull back and relax the control bar to a position of no less than 9 in from the compression strut ideally before the trike reaches 12 in from the ground. Never leave ground effect with the control bar at or less than 9 in from the compression strut. These high angle of attack maneuvers are safe at or below 12 in AGL and above 1000ft AGL giving the pilot enough time to recover from an inadvertent stall. Stalling the Competition 11 wing at or below 12 in should provide a very soft landing.

NOTE

While stall is very normal with a very soft break when this wing is dry, generally when it is wet, it can tip stall and have one wing tip drop first. Therefore avoid stalling when wet.

12.4 Rival (discontinued) / Rival S 12.4 Wing

The Rival S wing is recommended for beginner to advanced pilots. This does not mean a beginner who was trained and soloed on a larger, less responsive wing can fly a Rival S wing without difficulty or danger to themselves without transition training. Flight schools around the world are using the Rival S wing to teach new students to fly a trike, and many of those students are soloing with the Rival S wing as their first wing. Trike pilots should have an instructor's approval before flying a Rival S wing or a high degree of skill to transition to this wing. The Rival S wing has **very sensitive controls** and **WE RECOMMEND TRANSITION TRAINING**. Due to muscle memory, many high time trike pilots cannot resist over controlling this wing and will **NEED**, transition training. Students just learning on the Rival S wing will learn to fly with much smaller control bar movements than most other wings. Small movements allow the wing to be flown with fingertip and hand movements as opposed to full arm movements when controlling the roll.

Due to the wing loading of this combination it is important to push the control bar forward to the front strut to initiate lift off. Failure to do so will cause excessive speed build up on the ground and create an abrupt swing through which can cause temporary loss of pitch control after liftoff. The takeoff ground roll on pavement for the Rival S wing varies greatly based on many factors such as weight, HP, atmospheric conditions and tuning. (see the Revo AOI for performance figures on the Revo carriage). Taking off in grass, downwind, uphill, or with a crosswind especially coming from over tree tops will further increase the takeoff distance well beyond many pilot's guestimates, so be sure you have more than enough runway. It is important to get to a safe climb out speed before leaving ground effect which is around a control bar position no closer than 9 in from the front strut. It is advised that as speed builds up the pilot leans forward out of the seat with their back straight in order to keep a bend in his/her arms (no locked elbows). Push the bar forward **ALL** of the way to touch the compression strut of the trike carriage **PRIOR** to lift off speed and then wait for the nose to lift as speed increases. As the nose wheel lifts, pull back and relax the control bar to a position of no less than 9 in from the compression strut ideally before the trike reaches 24 in from the ground. Never leave ground effect with the control bar at or less than 9 in from the compression strut. These high angle of attack maneuvers are safe at or below 24 in and above 1000 ft AGL giving the pilot enough time to recover from an inadvertent stall. Stalling the Rival S wing at or below 12 in should provide a very soft landing. Stalling from 24 in should be avoided, but will not cause damage unless the bar is pulled in during the stall.

WARNING

Leaving the bar pushed out after the trike takes off can cause a possible stall.

Roll control on the Rival S wing should be done with extremely small horizontal bar movement. Instead we recommend holding pressure to turn. This works much more precisely than “bumping” the controls from side to side. It is very common for even advanced pilots to over control The Rival S during the first minutes of flight on the new wing. We suggest flying the Rival S in calm conditions and making an effort to move the control bar no more than 1 in from side to side until the pilot has the feel of the wing and is comfortable with the responsiveness. If able to get transition training from an experienced instructor we highly recommend it. The controls are not difficult to use as much as they are extremely light and responsive compared to the vast majority of trike wings on the market today. Flying in the Rival S wing simply allows movements to be small enough and light enough to reduce fatigue so long as the pilot does not over-control the wing which creates perpetual effort to continue flight. Moving the bar 1 in and holding pressure for 4 secs works much better than moving the bar 4 in for 1 sec.

NOTE

The Rival S will want to continue rolling in the direction the pilot initiated the bank. Once the trike rolls to the desired bank angle PUSH THE BAR STRAIGHT FORWARD.

This will “**coordinate**” the turn and stop the trike from continuing to roll into the turn. If the bar is pushed forward too abruptly, the trike will start leveling back out. Pilots that give opposite roll input (move the control bar to the right to stop the trike from banking too steeply to the right) will cause the wing to Dutch Roll which will cause additional control force needed on the control bar. This technique is highly inefficient and will cause the Rival S to slip sideways through the air. Understanding how to coordinate turns with the Rival S is one of the keys to mastering this wings capabilities. As your skills with the Rival S advance you can make fast turns using the “J” maneuver and experience over 90° of roll rate per second. This technique should be learned from an experienced instructor. The Rival S has the capability to radically bank faster than most trike pilots will ever want, small soft inputs result in smooth controlled turns.

Taxiing the Rival S wing does **NOT** require the upwind wingtip to be lowered. In fact, due to the amount of anhedral in the frame it is recommended to bank the wing slightly away from the wind making the upwind wing tip slightly higher (bank wing 5°-10°) to relieve side load control bar pressure on the pilot when taxiing. For this same reason taking off in a crosswind requires the upwind wingtip to be raised slightly (5°-10°) on the ground roll and leveled as the trike lifts off.

12.5 RIVAL X Wing

The RIVAL X wing has almost no unique characteristics or special training required specific to this combination of wing/carriage. The exception to this is when rolled very quickly the bar should be moved forward to “coordinate” the turn. Failure to do so can result in altitude loss and or a PIO.